

AM TRAN SCHOOL BUS

2000-97 8 CYL. RE MODELS w/T444E DIESEL, REAR ENGINE

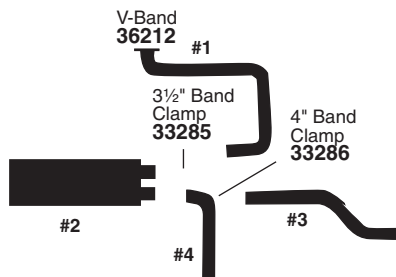

Part Code	#1	#2	#3	#4
W.B.	Front Exhaust Pipe	Muffler	Tail Pipe (Rear Exit)	Tail Pipe (Side Exit)
195" - 276"	53197 (99-97) 53198 (2000)	21300	55115	53199

BLUEBIRD SCHOOL BUS

2001-99 6 CYL. ALL AMERICAN w/CATERPILLAR 3126 DIESEL, REAR ENGINE

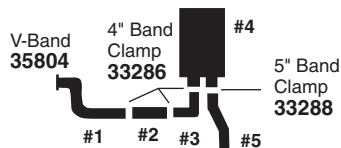

Part Code	#1	#2	#3	#4	#5
W.B.	Front Exh. Pipe	Flex Tubing	Rear Ext. Pipe	Muffler	Tail Pipe
All	●53604	41756	●52391	●22814	●55464 (Under Bumper) ●56169 (Thru Bumper) ●55465 (Thru Bumper Option)

● New number.

**If welded assembly, replace all required parts.
WARNING: Reuse or replace O.E. Heat Shields.**

BLUEBIRD SCHOOL BUS

2001-99 6 CYL. TC2000 w/CUMMINS 8.3L ISC DIESEL, REAR ENGINE MODELS

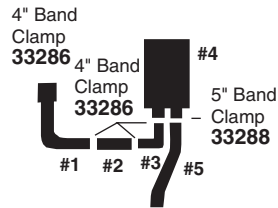

Part Code	#1	#2	#3	#4	#5
W.B.	Front Exh. Pipe	Flex Tubing	Rear Ext. Pipe	Muffler	Tail Pipe
All	●52393	41756	●52392	●22814	●55464 (Under Bumper) ●56169 (Thru Bumper)

1998-95 6 CYL. TC2000 w/6BTA 5.9L TURBO DIESEL REAR EXIT TAIL PIPE, SIDE MOUNTED FUEL TANK, w/CONVERTER

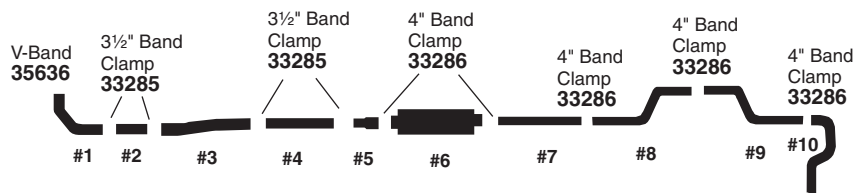

Part Code	#1	#2	#3	#4	#5	#6	#7	#8		#9	#10
								Front	Rear		
W.B.	Exhaust Pipe	Flex Tubing	Front Ext. Pipe	Rear Ext. Pipe	Adapter	Conv./Muffler	Ext. Pipe	Over Axle Pipe		Tail Pipe	
132"	41830	42065 ³	44002	41976 ³	42956	N.A.	46874 ³	43324	49194 ³	55056	
146" - 195"	41830	42065 ³	44132	41976 ³	42956	N.A.	46874 ³	43324	49194 ³	55056	
216" - 237"	41830	42065 ³	44132	49159 ³	42956	N.A.	46874 ³	43324	49194 ³	55056	

● New number.
 N.A. Not available.
 3 Cut to required length.

**If welded assembly, replace all required parts.
 WARNING: Reuse or replace O.E. Heat Shields.**

INFORMATION & BUILD TO ORDER

TOOLS AND ACCESSORIES

SCHOOL BUS

MEDIUM DUTY TRUCK GVV 3-6

HEAVY DUTY TRUCK GVV 7-8

APPLICATION BY ENGINE

NOISE AND BACKPRESSURE DATA

TRACTOR

MUFFLER SPECS

O.E. CROSS INDEX

BLUEBIRD SCHOOL BUS

1998-92 6 CYL. ALL AMERICAN w/CUMMINS 8.3L TURBO DIESEL, SPRING FRONT SUSPENSION, MID MOUNTED FUEL TANK (FROM CHASSIS NO. 977611), 5" TAIL PIPE THROUGH REAR BUMPER

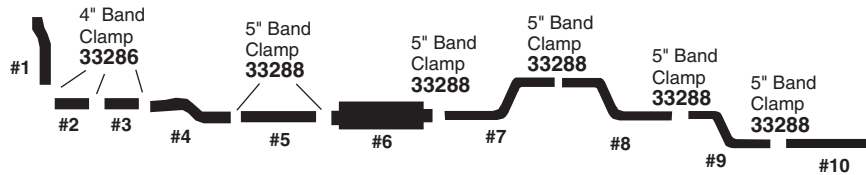

Part Code	#1	#2	#3	#4	#5	#6	#7	#8	#9	#10	
	W.B.	Exhaust Pipe	Flex Tubing	Crossover Pipe	Front Ext. Pipe	Rear Ext. Pipe	Muffler	Over Axle Pipe		Ext. Pipe	Tail Pipe
								Front	Rear		
	175" - 190"	N.A. (95-92) 52089 (97-96)	42423 ³	42891 ³	N.A.	49162 ³	22963* 22920	53031	54018	54019	45340 ³
	197½" - 227½"	N.A. (95-92) 52089 (97-96)	42423 ³	42891 ³	N.A.	49162 ³	22963* 22920	53031	54018	54019	49162 ³
	235" - 242½"	N.A. (95-92) 52089 (97-96)	42423 ³	42891 ³	N.A.	49162 ³ w/42126	22963* 22920	53031	54018	54019	49162 ³

1998-92 6 CYL. ALL AMERICAN w/CUMMINS 8.3L TURBO DIESEL, SPRING FRONT SUSPENSION, SIDE MOUNTED FUEL TANK (FROM CHASSIS NO. 977611), 5" TAIL PIPE

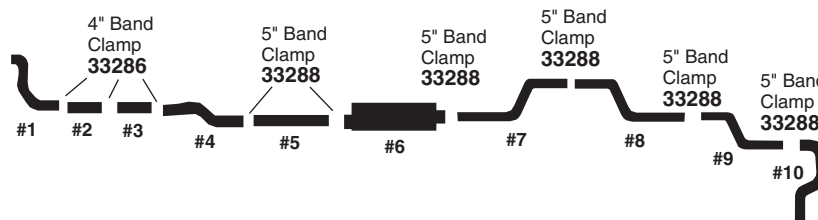

Part Code	#1	#2	#3	#4	#5	#6	#7	#8	#9	#10	
	W.B.	Exhaust Pipe	Flex Tubing	Crossover Pipe	Front Ext. Pipe	Rear Ext. Pipe	Muffler	Over Axle Pipe		Ext. Pipe	Tail Pipe
								Front	Rear		
	175"	N.A. (95-92) 52089 (97-96)	42423 ³	42891 ³	N.A.	49162 ³	22963* 22920	53031	54018	44457 ³	N.A.
	190"	N.A. (95-92) 52089 (97-96)	42423 ³	42891 ³	N.A.	49162 ³	22963* 22920	53031	54018	45340 ³	N.A.
	197½" - 227½"	N.A. (95-92) 52089 (97-96)	42423 ³	42891 ³	N.A.	49162 ³	22963* 22920	53031	54018	49162 ³	N.A.
	235" - 242½"	N.A. (95-92) 52089 (97-96)	42423 ³	42891 ³	N.A.	49162 ³ w/42126	22963* 22920	53031	54018	49162 ³	N.A.

* Mega Flow Muffler.
N.A. Not available.
3 Cut to required length.

**If welded assembly, replace all required parts.
WARNING: Reuse or replace O.E. Heat Shields.**

BLUEBIRD SCHOOL BUS

1998-94 6 CYL. TC2000 w/CATERPILLAR 3116, 3126TA DIESEL, REAR ENGINE

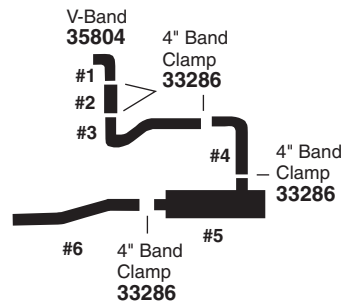

Part Code	#1	#2	#3	#4	#5	#6
W.B.	Exhaust Pipe	Flex Tubing	Front Ext. Pipe	Rear Ext. Pipe	Muffler w/Converter	Tail Pipe
All	●51034	41756	●54596	●53603	N.A.	●55463

1998-92 6 CYL. ALL AMERICAN w/CATERPILLAR 3116 (6.6L) DIESEL w/MID MOUNTED FUEL TANK, 5" TAIL PIPE THROUGH REAR BUMPER (FROM CHASSIS NO. 977303)

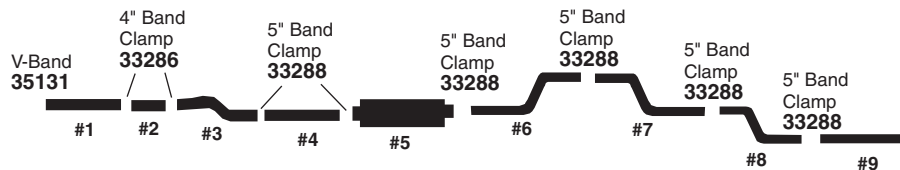

Part Code	#1	#2	#3	#4	#5	Over Axle Pipe		#8	#9
						Front	Rear		
W.B.	Exhaust Pipe	Flex Tubing	Front Ext. Pipe	Rear Ext. Pipe	Muffler			Ext. Pipe	Tail Pipe
175"	53108	41692 ³	N.A.	49162 ³	22963* 22920	53031	54018	54019	45340 ³
190" - 227½"	53108	41692 ³	N.A.	49162 ³	22963* 22920	53031	54018	54019	49162 ³
235" - 242½"	53108	41692 ³	N.A.	49162 ³ w/42126	22963* 22920	53031	54018	54019	49162 ³

- * Mega Flow Muffler.
- New number.
- N.A. Not available.
- 3 Cut to required length.

**If welded assembly, replace all required parts.
WARNING: Reuse or replace O.E. Heat Shields.**

INFORMATION & BUILD TO ORDER

TOOLS AND ACCESSORIES

SCHOOL BUS

MEDIUM DUTY TRUCK GVV 3-6

HEAVY DUTY TRUCK GVV 7-8

APPLICATION BY ENGINE

NOISE AND BACKPRESSURE DATA

TRACTOR

MUFFLER SPECS

O.E. CROSS INDEX

BLUEBIRD SCHOOL BUS

1998-92 6 CYL. ALL AMERICAN w/CATERPILLAR 3116 (6.6L) DIESEL SIDE MOUNTED FUEL TANK, 5" TAIL PIPE (FROM CHASSIS NO. 977303)

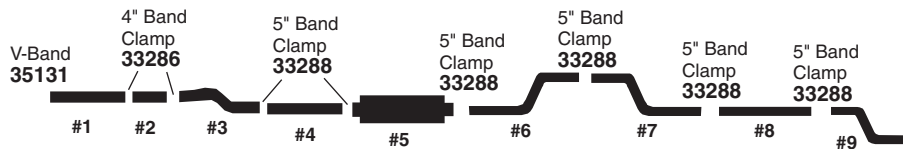

Part Code	#1	#2	#3	#4	#5	#6	#7	#8	#9
W.B.	Exhaust Pipe	Flex Tubing	Front Ext. Pipe	Rear Ext. Pipe	Muffler	Over Axle Pipe		Ext. Pipe	Tail Pipe
						Front	Rear		
175"	53108	41692 ³	N.A.	49162 ³	22963* 22920	53031 (95-92) 53107 (97-96)	54018	44457 ³	N.A.
190"	53108	41692 ³	N.A.	49162 ³	22963* 22920	53031 (95-92) 53107 (97-96)	54018	45340 ³	N.A.
197½" - 227½"	53108	41692 ³	N.A.	49162 ³	22963* 22920	53031 (95-92) 53107 (97-96)	54018	49162 ³	N.A.
235" - 242½"	53108	41692 ³	N.A.	49162 ³ w/42126	22963* 22920	53031 (95-92) 53107 (97-96)	54018	49162 ³	N.A.

1997-88 6 CYL. TC-2000 w/6BTA 5.9L TURBO DIESEL, REAR EXIT TAIL PIPE, MID MOUNTED FUEL TANK w/CODES 4452, 4453, 4513, 4514

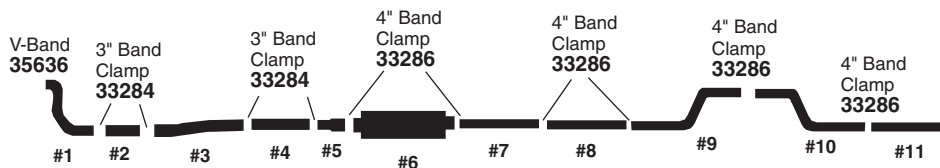

Part No.	#1	#2	#3	#4	#5	#6	#7	#8	#9	#10	#11
W.B.	Exhaust Pipe	Flex Tubing	Front Ext. Pipe	Rear Ext. Pipe	Adapter	Muffler	Front Ext. Pipe	Rear Ext. Pipe	Over Axle Pipe		Tail Pipe
									Front	Rear	
132"	42528	42065 ³	44002	N.A.	42956	22965*	46874	—	43324	46887	49161 ³
146" - 174"	42528	42065 ³	44132	41976 ³	42956	22965*	46874	—	43324	46887	49161 ³
195" - 216"	42528	42065 ³	44132	49159 ³	42956	22965*	46874	—	43324	46887	49161 ³
237"	42528	42065 ³	44132	49159 ³	42956	22965*	46874	49161 ³	43324	46887	49161 ³

* Mega Flow Muffler.
 N.A. Not available.
 3 Cut to required length.

**If welded assembly, replace all required parts.
 WARNING: Reuse or replace O.E. Heat Shields.**

BLUEBIRD SCHOOL BUS

1995-92 8 CYL. CV-200 w/366, 427 C.I.D. GAS ENGINE w/CONVERTER, TAIL PIPE EXITS AT THE REAR OF BUS

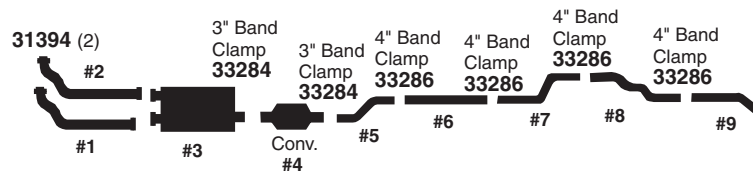

Part Code	#1	#2	#3	#4	#5	#6	#7		#8	#9
	LH Front Exhaust Pipe	RH Front Exhaust Pipe	Muffler	Converter	Front Ext. Pipe	Rear Ext. Pipe	Over Axle Pipe		Tail Pipe	
W.B.	N.A.	N.A.	22566	N.A.	N.A.	49161 ³	Front	Rear	49158	
145"	N.A.	N.A.	22566	N.A.	N.A.	49161 ³	43191	47674	49158	
157" - 193"	N.A.	N.A.	22566	N.A.	N.A.	49161 ³	43191	47674	49158	
209" - 261"	N.A.	N.A.	22566	N.A.	44545	49161 ³	43191	47674	49158	

1995-92 8 CYL. CV-200 w/366, 427 C.I.D. GAS ENGINE, SIDE EXIT TAIL PIPE EXITS BEHIND LEFT REAR WHEEL, w/CONVERTER

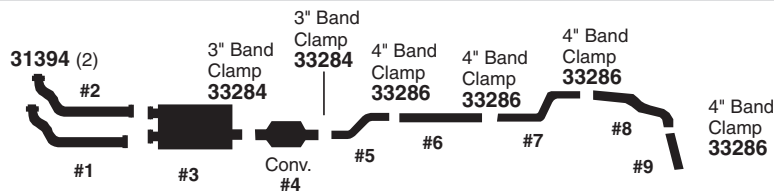

Part Code	#1	#2	#3	#4	#5	#6	#7		#8	#9
	LH Front Exhaust Pipe	RH Front Exhaust Pipe	Muffler	Converter	Front Ext. Pipe	Rear Ext. Pipe	Over Axle Pipe		Tail Pipe	
W.B.	N.A.	N.A.	22566	N.A.	N.A.	49161 ³	Front	Rear	N.A.	
145"	N.A.	N.A.	22566	N.A.	N.A.	49161 ³	43191	N.A.	N.A.	
157" - 193"	N.A.	N.A.	22566	N.A.	N.A.	49161 ³	43191	N.A.	N.A.	
209" - 261"	N.A.	N.A.	22566	N.A.	44545	49161 ³	43191	N.A.	N.A.	

N.A. Not available.
3 Cut to required length.

**If welded assembly, replace all required parts.
WARNING: Reuse or replace O.E. Heat Shields.**

BLUEBIRD SCHOOL BUS

1995-92 8 CYL. CV-200 w/366, 427 C.I.D GAS ENGINE, SIDE EXIT TAIL PIPE
EXITS IN FRONT OF LEFT REAR WHEEL, w/CONVERTER

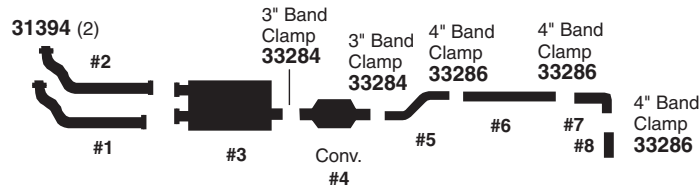

Part Code	#1	#2	#3	#4	#5	#6	#7	#8
W.B.	LH Front Exhaust Pipe	RH Front Exhaust Pipe	Muffler	Converter	Front Ext. Pipe	Rear Ext. Pipe	Elbow	Tail Pipe
145"	N.A.	N.A.	22566	N.A.	N.A.	49161 ³	N.A.	N.A.
157" - 193"	N.A.	N.A.	22566	N.A.	N.A.	49161 ³	N.A.	N.A.
209" - 261"	N.A.	N.A.	22566	N.A.	44545	49161 ³	N.A.	N.A.

1995-88 6 CYL. TC2000 w/6BTA 5.9L TURBO DIESEL, AUTO. TRANS. REAR EXIT TAIL PIPE

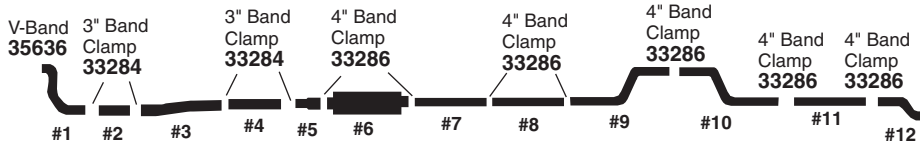

Part Code	#1	#2	#3	#4	#5	#6	#7	#8	#9		#11	#12
									Front	Rear		
W.B.	Exhaust Pipe	Flex Tubing	Front Ext. Pipe	Rear Ext. Pipe	Adapter	Muffler	Front Ext. Pipe	Rear Ext. Pipe	Over Axle Pipe		Ext. Pipe	Tail Pipe
132"	42955	42065 ³	44002	N.R.	42956	22965*	42305	N.R.	43196	44557	49161 ³	46844
146"	42955	42065 ³	44132	41976	42956	22965*	42305	49161 ³	43196	44557	49161 ³	46844
174" - 237"	42955	42065 ³	44132	49159 ³	42956	22965*	42305	49161 ³	43196	44557	49161 ³	46844

1995-88 6 CYL. TC2000 w/6BTA 5.9L TURBO DIESEL, MAN. TRANS., REAR EXIT TAIL PIPE

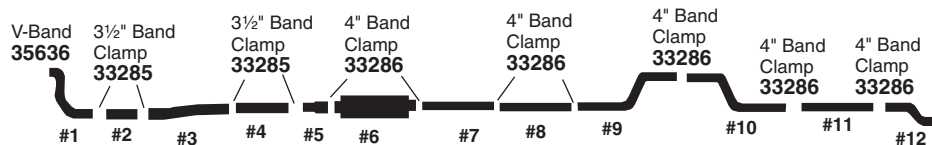

Part Code	#1	#2	#3	#4	#5	#6	#7	#8	#9		#11	#12
									Front	Rear		
W.B.	Exhaust Pipe	Flex Tubing	Front Ext. Pipe	Rear Ext. Pipe	Adapter	Muffler	Front Ext. Pipe	Rear Ext. Pipe	Over Axle Pipe		Ext. Pipe	Tail Pipe
132"	N.A.	42065 ³	N.A.	N.R.	42956	22965*	42305 ⁴	N.A.	43196	N.A.	49161 ³	46844
146" - 237"	N.A.	42065 ³	N.A.	49159 ³	42956	22965*	42305 ⁴	49161 ³	43196	44557	49161 ³	46844

- * Mega Flow Muffler.
- N.A. Not available.
- N.R. Not required.
- 3 Cut to required length.
- 4 w/Spring Suspension.

**If welded assembly, replace all required parts.
WARNING: Reuse or replace O.E. Heat Shields.**

BLUEBIRD SCHOOL BUS

1995-88 6 CYL. TC2000 w/6BTA 5.9L TURBO DIESEL, LH EXIT TAIL PIPE

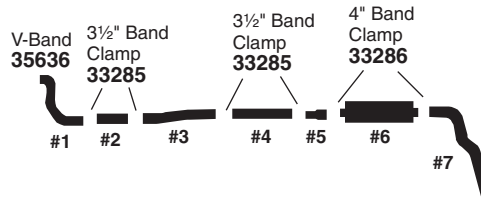

Part Code	#1	#2	#3	#4	#5	#6	#7
W.B.	Exhaust Pipe	Flex Tubing	Front Ext. Pipe	Rear Ext. Pipe	Adapter	Muffler	Tail Pipe
132"	42955 (Auto. Trans.) N.A. (Man. Trans.)	42065 ³	44002 (Auto. Trans.) N.A. (Man. Trans.)	49159 ³	42956	22965*	47643
146" - 237"	42955 (Auto. Trans.) N.A. (Man. Trans.)	42065 ³	44200	49159 ³	42956	22965*	47643

1994-88 6 CYL. TC2000 w/6BTA 5.9L TURBO DIESEL, REAR EXIT TAIL PIPE, SIDE MOUNTED FUEL TANK

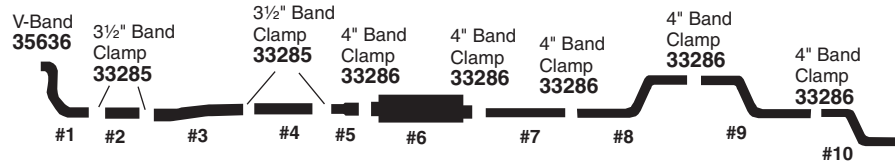

Part Code	#1	#2	#3	#4	#5	#6	#7	#8		#9	#10
								Over Axle Pipe			
W.B.	Exhaust Pipe	Flex Tubing	Front Ext. Pipe	Rear Ext. Pipe	Adapter	Muffler	Ext. Pipe	Front	Rear	Tail Pipe	
132"	42528	42065 ³	44002	41976 ³	42956	22965*	46874 ³	43324	49194 ³	45509	
146" - 195"	42528	42065 ³	44132	41976 ³	42956	22965*	46874 ³	43324	49194 ³	45509	
216" - 237"	42528	42065 ³	44132	49159 ³	42956	22965*	46874 ³	43324	49194 ³	45509	

1992-91 6 CYL. ALL AMERICAN w/CAT. 3116 TURBO DIESEL, w/4" REAR EXIT TAIL PIPE (BEFORE CHASSIS NO. 977303)

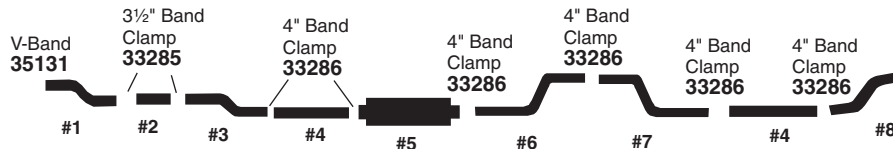

Part Code	#1	#2	#3	#4	#5	#6		#7	#8
						Over Axle Pipe			
W.B.	Front Exhaust Pipe	Flex Tubing	Front Ext. Pipe	Rear Ext. Pipe	Muffler	Front	Rear	Tail Pipe	
175" - 197 1/2"	N.A.	41756	N.A.	49161 ³	22965*	N.A.	N.A.	N.A.	
205" - 242 1/2"	N.A.	41756	N.A.	49052 ³	22965*	N.A.	N.A.	N.A.	

* Mega Flow Muffler.
N.A. Not available.
3 Cut to required length.

**If welded assembly, replace all required parts.
WARNING: Reuse or replace O.E. Heat Shields.**

INFORMATION & BUILD TO ORDER

TOOLS AND ACCESSORIES

SCHOOL BUS

MEDIUM DUTY TRUCK GVV 3-6

HEAVY DUTY TRUCK GVV 7-8

APPLICATION BY ENGINE

NOISE AND BACKPRESSURE DATA

TRACTOR

MUFFLER SPECS

O.E. CROSS INDEX

BLUEBIRD SCHOOL BUS

1992-88 8 CYL. ALL AMERICAN w/8.2LT, 8.2LTA FRONT ENGINE MODELS, REAR EXIT TAIL PIPE

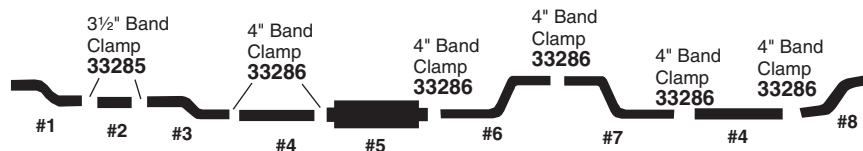

Part Code	#1	#2	#3	#4	#5	#6	#7	#8
W.B.	Exhaust Pipe	Flex Tubing	Front Ext. Pipe	Ext. Pipe	Muffler	Over Axle Pipe		Tail Pipe
						Front	Rear	
175" - 242 1/2"	N.A.	42066 ³	N.A.	49161 ³	22965*	N.A.	N.A.	N.A.

1988-92 8 CYL. ALL AMERICAN w/CUMMINS 8.3L FRONT ENGINE MODELS, w/4" EXHAUST (BEFORE CHASSIS NO. 977611)

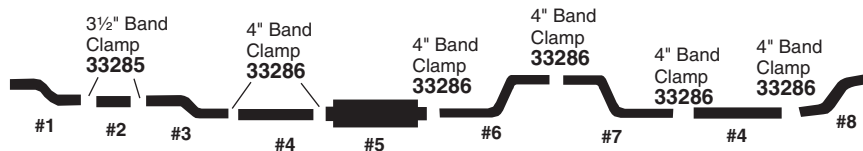

Part Code	#1	#2	#3	#4	#5	#6	#7	#8
W.B.	Exhaust Pipe	Flex Tubing	Front Ext. Pipe	Ext. Pipe	Muffler	Over Axle Pipe		Tail Pipe
						Front	Rear	
175" - 242 1/2"	N.A.	42066 ³	N.A.	49161 ³	22965*	N.A.	N.A.	N.A.

1991-88 8 CYL. ALL MODELS w/366 C.I.D. ENGINE w/CONVERTER

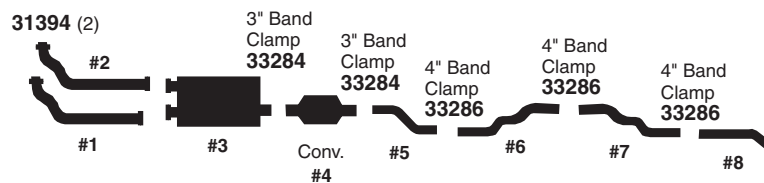

Part Code	#1	#2	#3	#4	#5	#6	#7	#8
W.B.	LH Front Exhaust Pipe	RH Front Exhaust Pipe	Muffler	Converter	Ext. Pipe	Over Axle Pipe		Tail Pipe
						Front	Rear	
254"	44224	44215	22566	N.A.	44545	46713	45007	49158
274"	44224	44215	22566	N.A.	44545	48278	45007	49158

* Mega Flow Muffler.
 N.A. Not available.
 3 Cut to required length.

**If welded assembly, replace all required parts.
 WARNING: Reuse or replace O.E. Heat Shields.**

BLUEBIRD SCHOOL BUS

1991-88 8 CYL. ALL MODELS w/366 C.I.D. ENGINE w/CONVERTER

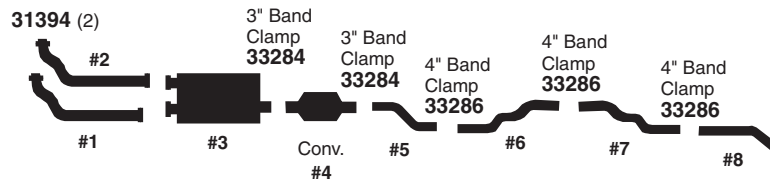

Part Code	#1	#2	#3	#4	#5	#6		#7	#8
	W.B.	LH Front Exhaust Pipe	RH Front Exhaust Pipe	Muffler	Converter	Ext. Pipe	Over Axle Pipe		Tail Pipe
							Front	Rear	
254"	44224	44215	22566	N.A.	44545	46713	45007	49158	
274"	44224	44215	22566	N.A.	44545	48278	45007	49158	

1987-85 8 CYL. MICRO-BIRD MODELS w/G30 CHASSIS, 350 C.I.D., AUTO. TRANS.

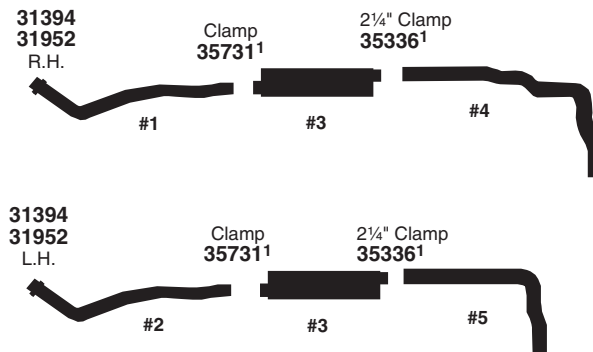

Part Code	#1	#2	#3	#4	#5
W.B.	RH Front Exhaust Pipe	LH Front Exhaust Pipe	RH & LH Muffler	RH Tail Pipe	LH Tail Pipe
125"	N.A.	N.A.	22467@	N.A.	N.A.
146"	N.A.	N.A.	22467@	N.A.	N.A.

@ Stainless Steel.
 N.A. Not available.
 1 For other clamp options, see page 18.

**If welded assembly, replace all required parts.
 WARNING: Reuse or replace O.E. Heat Shields.**

INFORMATION & BUILD TO ORDER
 TOOLS AND ACCESSORIES
 SCHOOL BUS
 MEDIUM DUTY TRUCK GVV 3-6
 HEAVY DUTY TRUCK GVV 7-8
 APPLICATION BY ENGINE
 NOISE AND BACKPRESSURE DATA
 TRACTOR
 MUFFLER SPECS
 O.E. CROSS INDEX

BLUEBIRD SCHOOL BUS

1987-85 8 CYL. ALL AMERICAN MODELS w/CAT. 3208 DIESEL

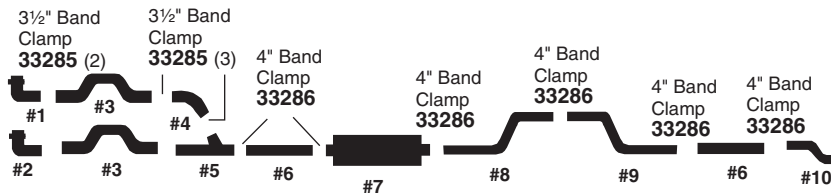

Part Code	#1	#2	#3	#4	#5	#6	#7	#8	#9	#10
W.B.	RH Exhaust Pipe	LH Exhaust Pipe	Over Axle Pipe	Ext. Pipe	Ext. Pipe	Ext. Pipe	Muffler	Over Axle Pipe		Tail Pipe
								Front	Rear	
149" - 216"	N.A.	N.A.	N.A.	N.A.	40419	49161 ³	22965*	N.A.	N.A.	N.A.
224" - 254"	N.A.	N.A.	N.A.	N.A.	40419	49052 ³	22965*	N.A.	N.A.	N.A.

1987-80 8 CYL. ALL AMERICAN w/8.2L TURBO DIESEL FRONT ENGINE MODELS, REAR EXIT TAIL PIPE

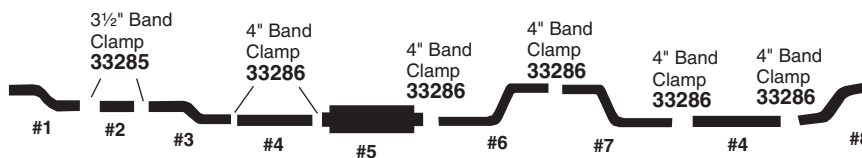

Part Code	#1	#2	#3	#4	#5	#6	#7	#8
W.B.	Exhaust Pipe	Flex Tubing	Front Ext. Pipe	Ext. Pipe	Muffler	Over Axle Pipe		Tail Pipe
						Front	Rear	
175" - 242 1/2"	N.A.	42066 ³	N.A.	49161 ³	22965*	N.A.	N.A.	N.A.

1987-80 8 CYL. ALL AMERICAN MODELS w/CUMMINS 555 DIESEL

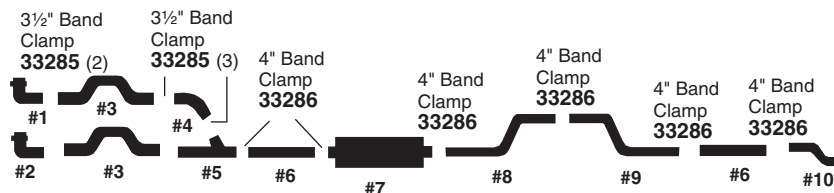

Part Code	#1	#2	#3	#4	#5	#6	#7	#8	#9	#10
W.B.	RH Exhaust Pipe	LH Exhaust Pipe	Over Axle Pipe	Ext. Pipe	Ext. Pipe	Ext. Pipe	Muffler	Over Axle Pipe		Tail Pipe
								Front	Rear	
149" - 216"	N.A.	N.A.	N.A.	N.A.	40419	49161 ³	22965*	N.A.	N.A.	N.A.
224" - 254"	N.A.	N.A.	N.A.	N.A.	40419	49052 ³	22965*	N.A.	N.A.	N.A.

* Mega Flow Muffler.
 N.A. Not available.
 3 Cut to required length.

If welded assembly, replace all required parts.
WARNING: Reuse or replace O.E. Heat Shields.

BLUEBIRD SCHOOL BUS

1987-80 8 CYL. ALL AMERICAN MODELS w/427 C.I.D. GAS ENGINE, REAR EXIT TAIL PIPE

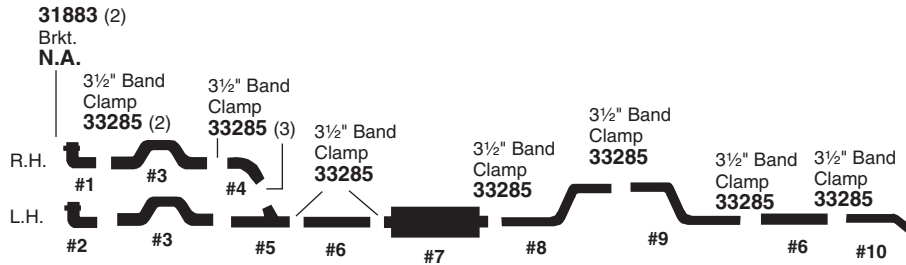

Part Code	#1	#2	#3	#4	#5	#6	#7	#8	#9	#10
W.B.	RH Front Exhaust Pipe	LH Front Exhaust Pipe	Front Over Axle Pipe	Ext. Pipe	Y-Pipe	Ext. Pipe	Muffler	Over Axle Pipe		Tail Pipe
								Front	Rear	
149" - 254"	N.A.	N.A.	N.A.	N.A.	N.A.	49160 ³	22844	N.A.	N.A.	N.A.

1984-80 8 CYL. ALL AMERICAN MODELS w/CUMMINS 504 DIESEL

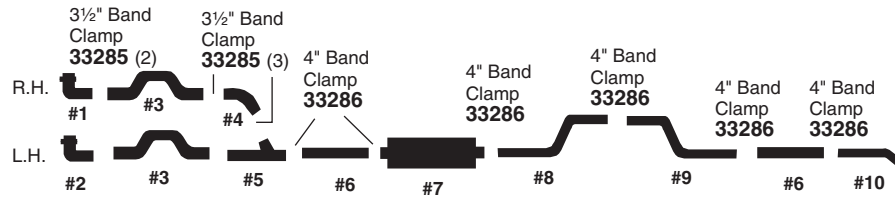

Part Code	#1	#2	#3	#4	#5	#6	#7	#8	#9	#10
W.B.	RH Exhaust Pipe	LH Exhaust Pipe	Over Axle Pipe	Ext. Pipe	Ext. Pipe	Ext. Pipe	Muffler	Over Axle Pipe		Tail Pipe
								Front	Rear	
149" - 216"	N.A.	N.A.	N.A.	N.A.	40419	49161 ³	22965*	N.A.	N.A.	N.A.
224" - 254"	N.A.	N.A.	N.A.	N.A.	40419	49052 ³	22965*	N.A.	N.A.	N.A.

1984-80 8 CYL. ALL AMERICAN MODELS w/CAT. 3208 DIESEL

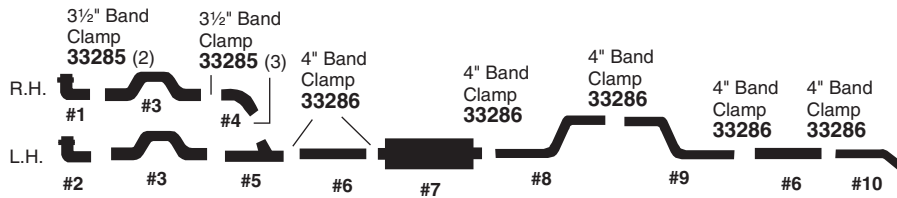

Part Code	#1	#2	#3	#4	#5	#6	#7	#8	#9	#10
W.B.	RH Exhaust Pipe	LH Exhaust Pipe	Over Axle Pipe	Ext. Pipe	Ext. Pipe	Ext. Pipe	Muffler	Over Axle Pipe		Tail Pipe
								Front	Rear	
149"	N.A.	41483	N.A.	N.A.	40419	49161 ³	22965*	N.A.	N.A.	N.A.
224"	N.A.	41483	N.A.	N.A.	40419	49052 ³	22965*	N.A.	N.A.	N.A.

* Mega Flow Muffler.
 N.A. Not available.
 3 Cut to required length.

**If welded assembly, replace all required parts.
 WARNING: Reuse or replace O.E. Heat Shields.**

INFORMATION & BUILD TO ORDER

TOOLS AND ACCESSORIES

SCHOOL BUS

MEDIUM DUTY TRUCK GVV 3-6

HEAVY DUTY TRUCK GVV 7-8

APPLICATION BY ENGINE

NOISE AND BACKPRESSURE DATA

TRACTOR

MUFFLER SPECS

O.E. CROSS INDEX

CHEVROLET SCHOOL BUS

1997-92 8 CYL. SERIES B6 ALL MODELS w/366, 427 C.I.D. GAS ENGINE w/CONVERTER, TAIL PIPE EXITS AT REAR OF BUS

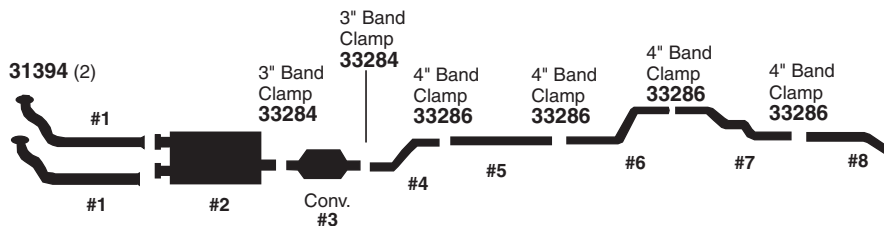

Part Code	#1	#2	#3	#4	#5	#6	#7	#8
W.B.	LH & RH Front Exhaust Pipe	Muffler	Converter	Front Ext. Pipe	Rear Ext. Pipe	Over Axle Pipe		Tail Pipe
						Front	Rear	
143" - 193"	53127 (LH) 54114 (RH)	22566	N.A.	N.A.	49161 ³	43191	47674	49158
209" - 261"	53127 (LH) 54114 (RH)	22566	N.A.	44545 ¹⁸	49161 ³	43191	47674	49158

1996-92 6 CYL. G30/G3500 MODELS w/262 C.I.D. (4.3L) ENG., 125" W.B., OVER 8500 G.V.W.R., w/CONVERTER

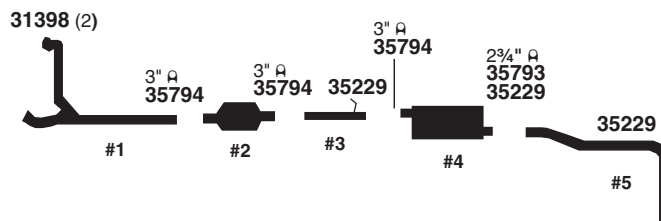

Part Code	#1	#2	#3	#4	#5
W.B.	Exhaust Pipe	Converter	Ext. Pipe	Muffler	Tail Pipe
125"	40342 ³³⁷	N.A.	42220	22678	44426

- N.A. Not available.
- 3 Cut to required length.
- 18 RH Fuel Tank.
- 337 If sensor required, drill 0.50" hole in pipe at sensor tap.

**If welded assembly, replace all required parts.
WARNING: Reuse or replace O.E. Heat Shields.**

CHEVROLET SCHOOL BUS

1996-91 8 CYL. G30/G3500 MODELS w/454 C.I.D. (7.4L) ENG., 125", 146" W.B., w/CONVERTER

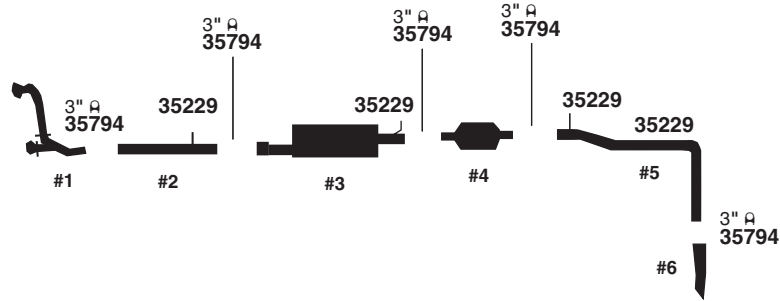

Part Code	#1	#2	#3	#4	#5	#6
W.B.	Exhaust Pipe	Ext. Pipe	Muffler	Converter	Tail Pipe	Tail Spout
125"	N.A.	N.R.	22934	N.A.	N.A.	41712 (Cutaway)
146"	N.A.	43793	22934	N.A.	N.A.	41712 (Cutaway)

1996-90 8 CYL. P30/P3500 MODELS w/454 C.I.D. (7.4L) ENG., w/CONVERTER

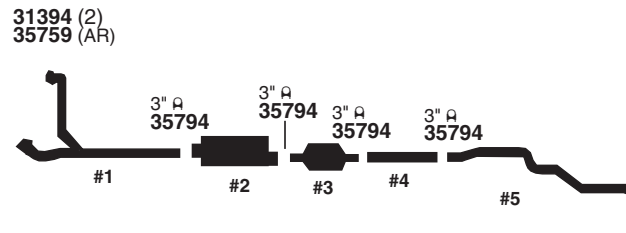

Part Code	#1	#2	#3	#4	#5
W.B.	Exhaust Pipe	Muffler	Converter	Ext. Pipe	Tail Pipe
133", 137"	N.A.	22679	N.A.	42606 ³	47659 ³⁷⁰
157"	N.A.	22679	N.A.	44119	47659 ³⁷⁰
158½", 178"	N.A.	22679	N.A.	N.A.	47659 ³⁷⁰
190", 208"	N.A.	22679	N.A.	N.A.	47659 ³⁷⁰

N.A. Not available.
 N.R. Not required.
 3 Cut to required length.
 370 Required (1) 42606 for Wide Body Models.

**If welded assembly, replace all required parts.
 WARNING: Reuse or replace O.E. Heat Shields.**

INFORMATION
& BUILD TO
ORDER

TOOLS AND
ACCESSORIES

SCHOOL BUS

MEDIUM
DUTY TRUCK
GVW 3-6

HEAVY DUTY
TRUCK
GVW 7-8

APPLICATION
BY ENGINE

NOISE AND
BACKPRESSURE
DATA

TRACTOR

MUFFLER
SPECS

O.E. CROSS
INDEX

CHEVROLET SCHOOL BUS

1996-89 8 CYL. P30/P3500 MODELS w/350 C.I.D., 125", 133", 157", 178" W.B., w/CONVERTER

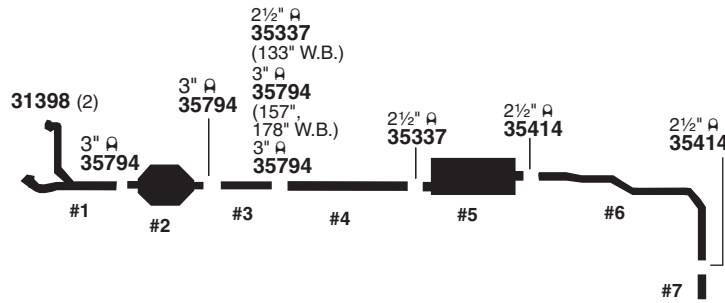

Part Code	#1	#2	#3	#4	#5	#6	#7
W.B.	Exhaust Pipe	Converter	Front Ext. Pipe	Rear Ext. Pipe	Muffler	Tail Pipe	Tail Spout
125"	40325 ²⁹¹ (90-89) (Exc. 4 Whl. Disc.) 40359 (90-89) (w/4 Whl. Disc.)	N.A.	41974 ³³⁸	N.R.	22499 ^{338,364}	46757 ^{338,372} (90-89) 47653 ^{338,372} (96-91)	42596
133"	40325 ²⁹¹ (90-89) (Exc. 4 Whl. Disc.) 40359 (90-89) (w/4 Whl. Disc.)	N.A.	41974 ³³⁸	41966 ³	22499 ^{338,364}	46757 ^{338,372} (90-89) 47653 ^{338,372} (96-91)	42596
157"	40325 ²⁹¹ (90-89) (Exc. 4 Whl. Disc.) 40359 (90-89) (w/4 Whl. Disc.)	N.A.	N.R.	44119	22499 ^{338,364}	46757 ^{338,372} (90-89) 47653 ^{338,372} (96-91)	42596
178"	40325 ²⁹¹ (90-89) (Exc. 4 Whl. Disc.) 40359 (90-89) (w/4 Whl. Disc.)	N.A.	42924	44119	22499 ^{338,364}	46757 ^{338,372} (90-89) 47653 ^{338,372} (96-91)	42596

1995-92 8 CYL. SERIES B6 ALL MODELS w/366, 427 C.I.D. GAS ENGINE w/CONVERTER, SIDE EXIT TAIL PIPE EXITS BEHIND REAR WHEEL

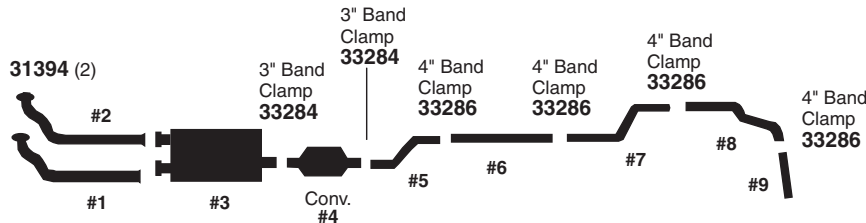

Part Code	#1	#2	#3	#4	#5	#6	#7	#8	#9
W.B.	LH Front Exhaust Pipe	RH Front Exhaust Pipe	Muffler	Converter	Front Ext. Pipe	Rear Ext. Pipe	Over Axle Pipe		Tail Pipe
							Front	Rear	
145" - 193"	44215	44224	22566	N.A.	N.A.	49161 ³	43191	N.A.	N.A.
209" - 261"	44215	44224	22566	N.A.	44545 ¹⁸	49161 ³	43191	N.A.	N.A.

- N.A. Not available.
- N.R. Not required.
- 3 Cut to required length.
- 18 RH Fuel Tank.
- 291 If Oxygen Sensor not used, Plug 35299 required.
- 338 Both parts required.
- 364 Tail Pipe required.
- 372 Required (1) 42596 for Wide Body Models.

**If welded assembly, replace all required parts.
WARNING: Reuse or replace O.E. Heat Shields.**

CHEVROLET SCHOOL BUS

1995-92 8 CYL. SERIES B6 ALL MODELS w/366, 427 C.I.D. GAS ENGINE w/CONVERTER, SIDE EXIT TAIL PIPE EXITS IN FRONT OF LEFT WHEEL

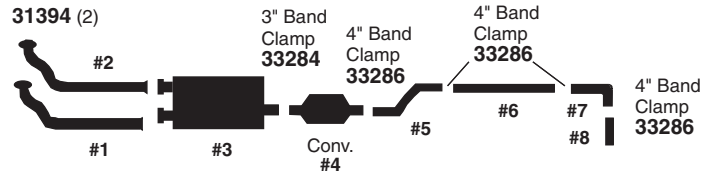

Part Code	#1	#2	#3	#4	#5	#6	#7	#8
W.B.	LH Front Exhaust Pipe	RH Front Exhaust Pipe	Muffler	Converter	Front Ext. Pipe	Rear Ext. Pipe	Elbow	Tail Pipe
145" - 193"	44215	44224	22566	N.A.	N.A.	49161 ³	N.A.	N.A.
209" - 261"	44215	44224	22566	N.A.	44545 ¹⁸	49161 ³	N.A.	N.A.

1995-90 8 CYL. P30/P3500 MODELS w/262 C.I.D. (4.3L) ENG., 125", 133", 157", 178" W.B., w/CONVERTER

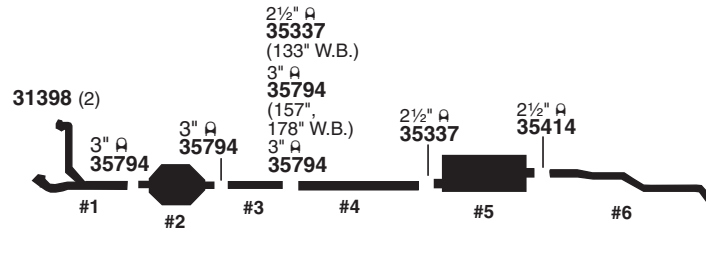

Part Code	#1	#2	#3	#4	#5	#6
W.B.	Exhaust Pipe	Converter	Front Ext. Pipe	Rear Ext. Pipe	Muffler	Tail Pipe
125"	40325 (1990)	N.A.	41974 ³³⁸	N.R.	22499 ^{338,364}	46757 ^{338,372} (1990) 47653 ^{338,372} (95-91)
133"	40325 (1990)	N.A.	41974 ³³⁸	N.R.	22499 ^{338,364}	46757 ^{338,372} (1990) 47653 ^{338,372} (95-91)
157"	40325 (1990)	N.A.	N.R.	44119	22499 ^{338,364}	46757 ^{338,372} (1990) 47653 ^{338,372} (95-91)
178"	40325 (1990)	N.A.	42924	44119	22499 ^{338,364}	46757 ^{338,372} (1990) 47653 ^{338,372} (95-91)

N.A. Not available.
 N.R. Not required.
 3 Cut to required length.
 18 RH Fuel Tank.

338 Both parts required.
 364 Tail Pipe required.
 372 Required (1) 42596 for Wide Body Models.

**If welded assembly, replace all required parts.
 WARNING: Reuse or replace O.E. Heat Shields.**

INFORMATION & BUILD TO ORDER

TOOLS AND ACCESSORIES

SCHOOL BUS

MEDIUM DUTY TRUCK GVV 3-6

HEAVY DUTY TRUCK GVV 7-8

APPLICATION BY ENGINE

NOISE AND BACKPRESSURE DATA

TRACTOR

MUFFLER SPECS

O.E. CROSS INDEX

CHEVROLET SCHOOL BUS

1994-91 6 CYL. G30/G3500 MODELS w/262 C.I.D. (4.3L) ENG., 125" W.B.,
UNDER 8500 G.V.W.R.

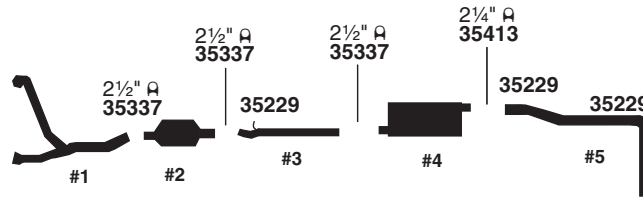

Part Code	#1	#2	#3	#4	#5
W.B.	Exhaust Pipe	Converter	Ext. Pipe	Muffler	Tail Pipe
125"	40343	N.A.	43486	21910	45354

1993-91 8 CYL. P30/P3500 MODELS w/379 C.I.D. (6.2L) DIESEL ENG.

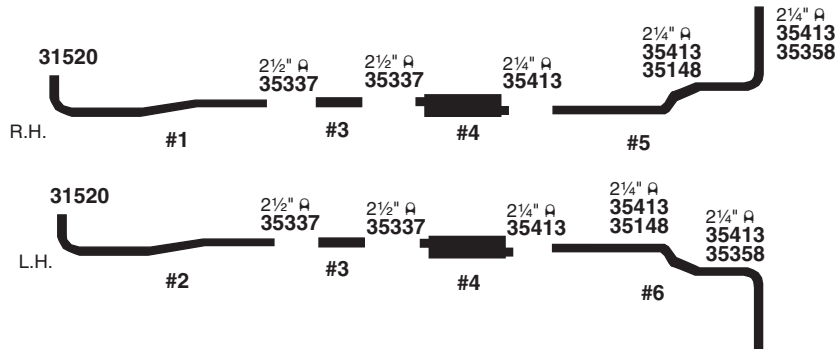

Part Code	#1	#2	#3	#4	#5	#6
W.B.	RH Exhaust Pipe	LH Exhaust Pipe	Ext. Pipe	Muffler	RH Tail Pipe	LH Tail Pipe
133", 137"	46753	46802	42956 ³	22644	47607 ³⁵⁷	47608 ³⁵⁷
157", 158 1/2"	46753	46802	43729	22644	47607 ³⁵⁷	47608 ³⁵⁷
178"	46753	46802	47555 ³	22644	47607 ³⁵⁷	47608 ³⁵⁷

N.A. Not available.
3 Cut to required length.
357 For wide body models, use 41956 on Tail Pipe Outlets.

**If welded assembly, replace all required parts.
WARNING: Reuse or replace O.E. Heat Shields.**

CHEVROLET SCHOOL BUS

1991-80 8 CYL. SERIES B6, S7 ALL MODELS w/8.2L DIESEL w/TURBO

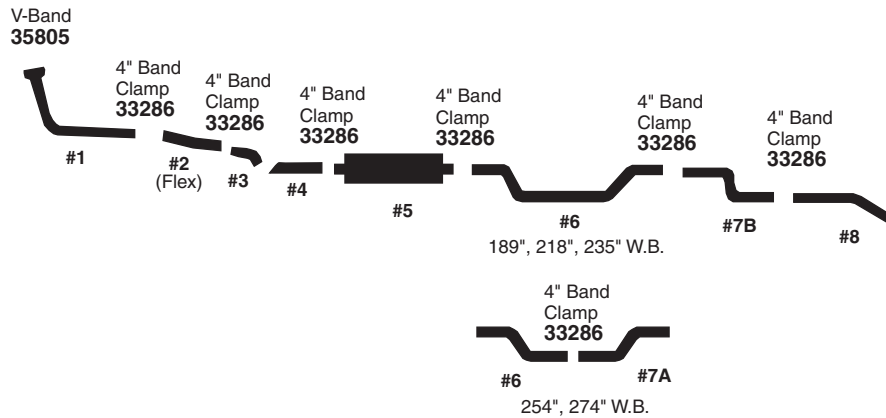

Part Code	#1	#2	#3	#4	#5	#6	#7A	#7B	#8
	W.B.	Exhaust Pipe	Flex Tubing	Ext. Pipe	Rear Ext. Pipe	Muffler	Ext. Pipe	Over Axle Pipe	
							Front	Rear	
189"	43627 (91-82)	42423 ³	41430	45512 (S-Series) 48280 ³² (B-Series)	22004	N.A.	N.R.	45007	49158 ³
218"	43627 (91-82)	42423 ³	41430	45512 (S-Series) 48280 ³² (B-Series)	22004	47625	N.R.	45007	49158 ³
235"	43627 (91-82)	42423 ³	41430	45512 (S-Series) 48280 ³² (B-Series)	22004	N.A.	N.R.	45007	49158 ³
254"	43627 (91-82)	42423 ³	41430	45512 (S-Series) 48280 ³² (B-Series)	22004	44982	46713	45007	49158 ³
274"	43627 (91-82)	42423 ³	41430	45512 (S-Series) 48280 ³² (B-Series)	22004	44982	48278	45007	49158 ³

N.A. Not available.
 N.R. Not required.
 3 Cut to required length.
 32 Auto. Trans.

**If welded assembly, replace all required parts.
 WARNING: Reuse or replace O.E. Heat Shields.**

INFORMATION & BUILD TO ORDER

TOOLS AND ACCESSORIES

SCHOOL BUS

MEDIUM DUTY TRUCK GVV 3-6

HEAVY DUTY TRUCK GVV 7-8

APPLICATION BY ENGINE

NOISE AND BACKPRESSURE DATA

TRACTOR

MUFFLER SPECS

O.E. CROSS INDEX

CHEVROLET SCHOOL BUS

1991-80 8 CYL. SERIES B6, S7 ALL MODELS w/8.2L DIESEL w/o TURBO

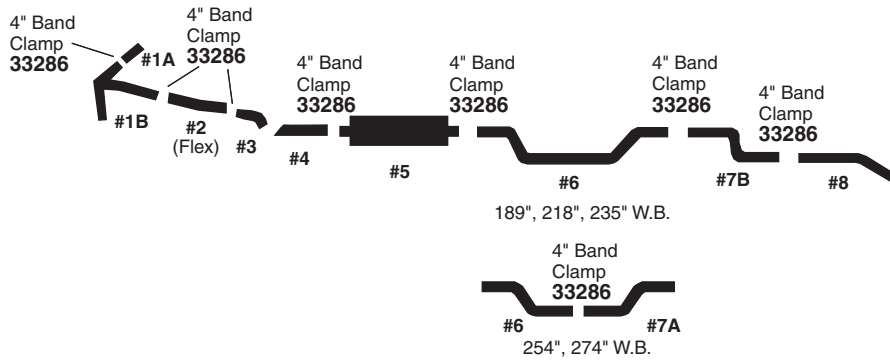

Part Code	#1A	#1B	#2	#3	#4	#5	#6	#7A	#7B	#8
	W.B.	RH Exhaust Pipe	LH Exhaust Pipe	Flex Tubing	Front Ext. Pipe	Rear Ext. Pipe	Muffler	Ext. Pipe	Over Axle Pipe	
								Front	Rear	
189"	41662	40358	42423 ³	41430 ³	N.A. (Front) 45512 (Rear, S-Series) 48280 ³ (Rear, B-Series)	22449	N.A.	N.R.	45007	49158 ³
218"	41662	40358	42423 ³	41430 ³	N.A. (Front) 45512 (Rear, S-Series) 48280 ³ (Rear, B-Series))	22449	47625	N.R.	45007	49158 ³
235"	41662	40358	42423 ³	41430 ³	N.A. (Front) 45512 (Rear, S-Series) 48280 ³ (Rear, B-Series)	22449	N.A.	N.R.	45007	49158 ³
254"	41662	40358	42423 ³	41430 ³	N.A. (Front) 45512 (Rear, S-Series) 48280 ³ (Rear, B-Series)	22449	44982	46713	45007	49158 ³
274"	41662	40358	42423 ³	41430 ³	N.A. (Front) 45512 (Rear, S-Series) 48280 ³ (Rear, B-Series)	22449	44982	48278	45007	49158 ³

N.A. Not available.
 N.R. Not required.
 3 Cut to required length.

**If welded assembly, replace all required parts.
 WARNING: Reuse or replace O.E. Heat Shields.**

CHEVROLET SCHOOL BUS

1991-89 8 CYL. SERIES B6 ALL MODELS w/366 C.I.D. ENG. w/CONVERTER

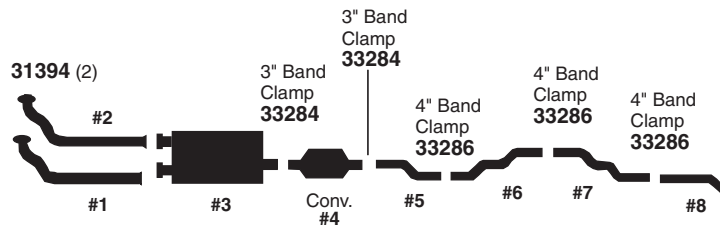

Part Code	#1	#2	#3	#4	#5	#6	#7	#8
	LH Front Exhaust Pipe	RH Front Exhaust Pipe	Muffler	Converter	Ext. Pipe	Over Axle Pipe		Tail Pipe
W.B.							Front	Rear
254"	44224	44215	22566	N.A.	44545	46713	45007	49158
274"	44224	44215	22566	N.A.	44545	48278	45007	49158

1990-85 8 CYL. SERIES B6 ALL MODELS w/350 C.I.D. GAS ENG., BALL & SOCKET, H5D EMISSIONS, MODELS BUILT AFTER 1-1-85

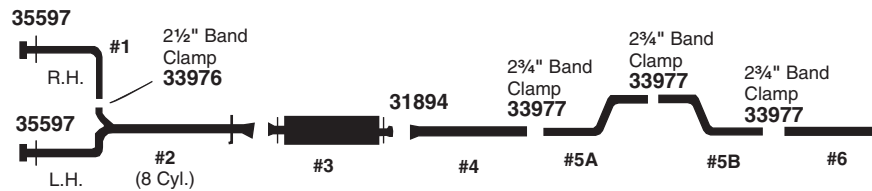

Part Code	#1	#2	#3	#4	#5A	#5B	#6
	RH Exhaust Pipe	LH Exhaust Pipe	Muffler	Ext. Pipe	Over Axle Pipe		Tail Pipe
W.B.					Front	Rear	
174"	43337@	N.A.	22906@	46605 w/31984	N.A.	45732	49148 ³
189"	43337@	N.A.	22906@	46605 w/31984	N.A.	45732	49148 ³
218" - 254"	43337@	N.A.	22906@	46605 w/31984	49149 ³	45732	49148 ³
274"	43337@	N.A.	22906@	N.A.	49149 ³	45732	49148 ³

@ Stainless Steel.
 N.A. Not available.
 3 Cut to required length.

**If welded assembly, replace all required parts.
 WARNING: Reuse or replace O.E. Heat Shields.**

INFORMATION & BUILD TO ORDER

TOOLS AND ACCESSORIES

SCHOOL BUS

MEDIUM DUTY TRUCK GVV 3-6

HEAVY DUTY TRUCK GVV 7-8

APPLICATION BY ENGINE

NOISE AND BACKPRESSURE DATA

TRACTOR

MUFFLER SPECS

O.E. CROSS INDEX

CHEVROLET SCHOOL BUS

1990-85 8 CYL. SERIES B6, S7 ALL MODELS w/366 C.I.D. GAS ENG., AUTOMATIC TRANSMISSION, H5D EMISSIONS, FEDERAL EMISSIONS - AFTER 1-1-85

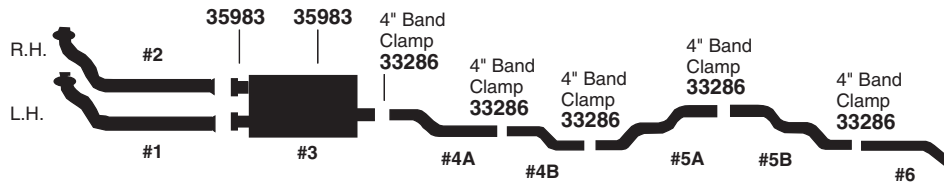

Part Code	#1	#2	#3	#4A	#4B	#5A	#5B	#6
W.B.	LH Front Exhaust Pipe	RH Front Exhaust Pipe	Muffler	Ext. Pipe	Ext. Pipe	Over Axle Pipe		Tail Pipe
						Front	Rear	
189"	44138@	44137@	22897 ¹⁰ @	45029	44983	N.R.	45007	49158
218"	44138@	44137@	22897 ¹⁰ @	45029	47625	N.R.	45007	49158
235"	44138@	44137@	22897 ¹⁰ @	45029	N.A.	N.R.	45007	49158
254"	44138@	44137@	22897 ¹⁰ @	45029	44982	46713	45007	49158
274"	44138@	44137@	22897 ¹⁰ @	45029	44982	48278	45007	49158

1987-85 8 CYL. SERIES B6, S7 w/366 C.I.D. GAS ENG., AUTO. TRANSMISSION, H5D EMISSIONS, MODELS BUILT AFTER 1-1-85, DUAL MUFFLER, BALL & SOCKET SYSTEM

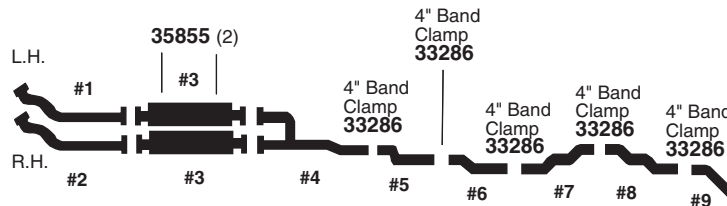

Part Code	#1	#2	#3	#4	#5	#6	#7	#8	#9
W.B.	LH Front Exhaust Pipe	RH Front Exhaust Pipe	Muffler (2 Req'd)	Front Ext. Pipe	Middle Ext. Pipe	Rear Ext. Pipe	Over Axle Pipe		Tail Pipe
							Front	Rear	
189"	44142@	44141@	22906@	N.A.	N.A.	N.A.	46713	45007	49158 ³
218"	44142@	44141@	22906@	N.A.	45029	47625	46713	45007	49158 ³
235"	44142@	44141@	22906@	N.A.	45029	N.A.	46713	45007	49158 ³
254"	44142@	44141@	22906@	N.A.	45029	44982	46713	45007	49158 ³
274"	44142@	44141@	22906@	N.A.	45029	44982	48278	45007	49158 ³

@ Stainless Steel.
 N.A. Not available.
 N.R. Not required.

3 Cut to required length.
 10 Requires (2) 35983 Muffler Hangers.

**If welded assembly, replace all required parts.
 WARNING: Reuse or replace O.E. Heat Shields.**

CHEVROLET SCHOOL BUS

1985-80 8 CYL. SERIES B6 ALL MODELS w/350 C.I.D. GAS ENG., BALL & SOCKET, BEFORE 1-1-85 (EXC. H5D EMISSIONS)

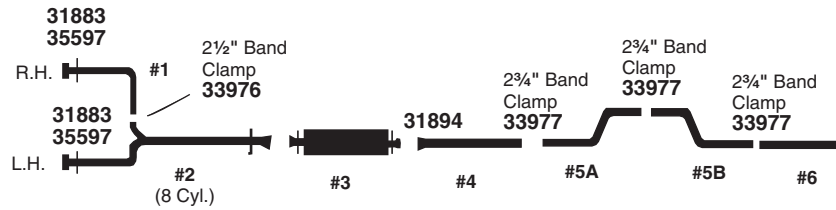

Part Code	#1	#2	#3	#4	#5A	#5B	#6	
	W.B.	RH Exhaust Pipe	LH Exhaust Pipe	Muffler	Ext. Pipe	Over Axle Pipe		Tail Pipe
						Front	Rear	
	174"	43885	40478	22878	46605 w/31984	N.A.	45732	49148 ³
	189"	43885	40478	22878	46605 w/31984	N.A.	45732	49148 ³
	218" - 254"	43885	40478	22878	46605 w/31984	49149 ³	45732	49148 ³
	274"	43885	40478	22878	N.A.	49149 ³	45732	49148 ³

1985-80 8 CYL. SERIES B6 ALL MODELS w/350 C.I.D. GAS ENG., CLAMP JOINT, MODELS BUILT BEFORE 1-1-85

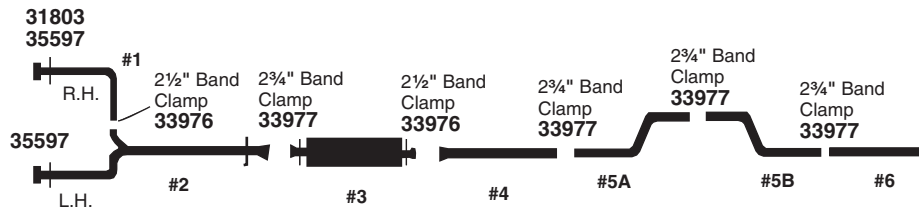

Part Code	#1	#2	#3	#4	#5A	#5B	#6	
	W.B.	RH Exhaust Pipe	LH Exhaust Pipe	Muffler	Ext. Pipe	Over Axle Pipe		Tail Pipe
						Front	Rear	
	174"	43752	40468	22852	46527	N.A.	45732	49148 ³
	189"	43752	40468	22852	46527	N.A.	45732	49148 ³
	218"	43752	40468	22852	46527	49149 ³	45732	49148 ³
	235"	43752	40468	22852	46527	49149 ³	45732	49148 ³
	254"	43752	40468	22852	46527	49149 ³	45732	49148 ³

N.A. Not available.
3 Cut to required length.

**If welded assembly, replace all required parts.
WARNING: Reuse or replace O.E. Heat Shields.**

INFORMATION & BUILD TO ORDER

TOOLS AND ACCESSORIES

SCHOOL BUS

MEDIUM DUTY TRUCK GVV 3-6

HEAVY DUTY TRUCK GVV 7-8

APPLICATION BY ENGINE

NOISE AND BACKPRESSURE DATA

TRACTOR

MUFFLER SPECS

O.E. CROSS INDEX

CHEVROLET SCHOOL BUS

1985-80 8 CYL. SERIES B6 ALL MODELS w/366, 427 C.I.D. GAS ENG., BALL & SOCKET, AT545 AUTOMATIC TRANSMISSION (EXC. H5D EMISSIONS) BEFORE 1-1-85

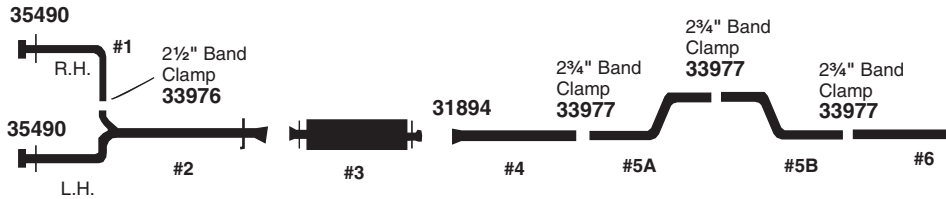

Part Code	#1	#2	#3	#4	#5A	#5B	#6
W.B.	RH Exhaust Pipe	LH Exhaust Pipe	Muffler	Ext. Pipe	Over Axle Pipe		Tail Pipe
					Front	Rear	
174"	42790@	40318@	22878	46605 w/31984	N.A.	45732	49148 ³
189"	42790@	40318@	22878	46605 w/31984	N.A.	45732	49148 ³
218"	42790@	40318@	22878	46605 w/31984	49149 ³	45732	49148 ³
235"	42790@	40318@	22878	46605 w/31984	49149 ³	45732	49148 ³
254"	42790@	40318@	22878	46605 w/31984	49149 ³	45732	49148 ³
274"	42790@	40318@	22878	N.A.	49149 ³	45732	49148 ³

1985-80 8 CYL. SERIES B6 ALL MODELS w/366, 427 C.I.D. GAS ENG., BALL & SOCKET, MANUAL TRANSMISSION, BEFORE 1-1-85

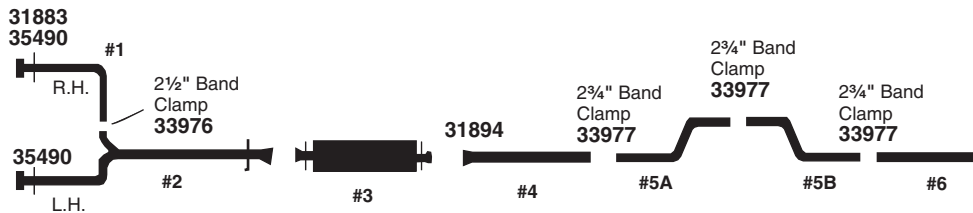

Part Code	#1	#2	#3	#4	#5A	#5B	#6
W.B.	RH Exhaust Pipe	LH Exhaust Pipe	Muffler	Ext. Pipe	Over Axle Pipe		Tail Pipe
					Front	Rear	
174"	43884 (83-80)	40399 (83-80)	22878	46605 w/31984	N.A.	45732	49148 ³
189"	43884 (83-80)	40399 (83-80)	22878	46605 w/31984	N.A.	45732	49148 ³
218"	43884 (83-80)	40399 (83-80)	22878	46605 w/31984	49149 ³	45732	49148 ³
235"	43884 (83-80)	40399 (83-80)	22878	46605 w/31984	49149 ³	45732	49148 ³
254"	43884 (83-80)	40399 (83-80)	22878	46605 w/31984	49149 ³	45732	49148 ³
274"	43884 (83-80)	40399 (83-80)	22878	N.A.	49149 ³	45732	49148 ³

@ Stainless Steel.
 N.A. Not available.
 3 Cut to required length.

**If welded assembly, replace all required parts.
 WARNING: Reuse or replace O.E. Heat Shields.**

CHEVROLET SCHOOL BUS

1985-80 8 CYL. ALL MODELS w/366, 427 C.I.D. GAS ENG., CLAMP JOINT, AUTOMATIC TRANSMISSION, BEFORE 1-1-85

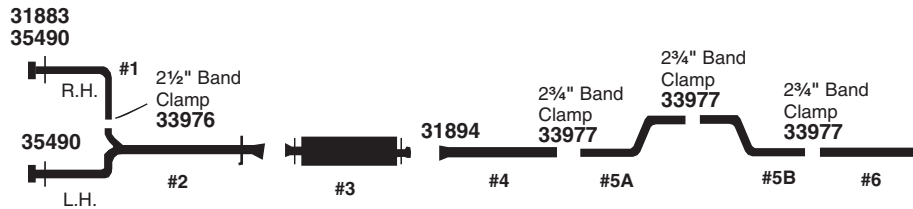

Part Code	#1	#2	#3	#4	#5A	#5B	#6
	RH Exhaust Pipe	LH Exhaust Pipe	Muffler	Ext. Pipe	Over Axle Pipe		Tail Pipe
					Front	Rear	
174"	42648	40479	22852	46527	N.A.	45732	49148 ³
189"	42648	40479	22852	46527	N.A.	45732	49148 ³
218"	42648	40479	22852	46527	49149 ³	45732	49148 ³
235"	42648	40479	22852	46527	49149 ³	45732	49148 ³
254" - 274"	42648	40479	22852	46527	49149 ³	45732	49148 ³

1985-80 8 CYL. ALL MODELS w/366, 427 C.I.D. GAS ENG., CLAMP JOINT, MANUAL TRANSMISSION, BEFORE 1-1-85

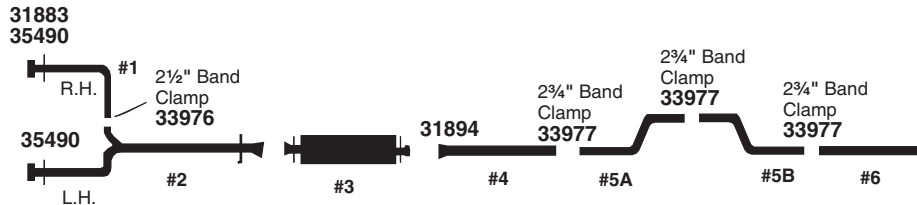

Part Code	#1	#2	#3	#4	#5A	#5B	#6
	RH Exhaust Pipe	LH Exhaust Pipe	Muffler	Ext. Pipe	Over Axle Pipe		Tail Pipe
					Front	Rear	
174"	43957	40484	22852	46527	N.A.	45732	49148 ³
189"	43957	40484	22852	46527	N.A.	45732	49148 ³
218"	43957	40484	22852	46527	49149 ³	45732	49148 ³
235"	43957	40484	22852	46527	49149 ³	45732	49148 ³
254" - 274"	43957	40484	22852	46527	49149 ³	45732	49148 ³

N.A. Not available.
3 Cut to required length.

**If welded assembly, replace all required parts.
WARNING: Reuse or replace O.E. Heat Shields.**

INFORMATION & BUILD TO ORDER

TOOLS AND ACCESSORIES

SCHOOL BUS

MEDIUM DUTY TRUCK GVV 3-6

HEAVY DUTY TRUCK GVV 7-8

APPLICATION BY ENGINE

NOISE AND BACKPRESSURE DATA

TRACTOR

MUFFLER SPECS

O.E. CROSS INDEX

FORD SCHOOL BUS

1998-95 6 CYL. B800 w/5.9L CUMMINS DIESEL w/CONVERTER, AIR SUSPENSION

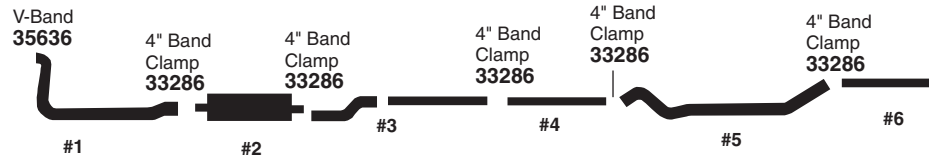

Part Code	#1	#2	#3	#4	#5	#6
W.B.	Front Exhaust Pipe	Conv./Muffler	Ext. Pipe	Over Axle Pipe	Ext. Pipe	Tail Pipe
151" - 275"	55092	N.A.	54175 (Front) 49161 ³ (Rear)	53192	48318	49161 ³

1996-93 8 CYL. E350 w/460 C.I.D. (7.5L) ENG. - 138", 158", 176" W.B.

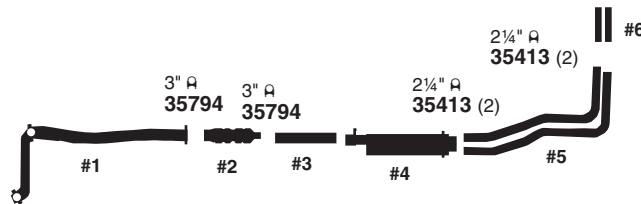

Part Code	#1	#2	#3	#4	#5	#6
W.B.	Exhaust Pipe	Converter	Ext. Pipe	Muffler	Tail Pipe	Tail Pipe
138"	N.A.	●15838 (1994) (96-95 Exc. Calif.)	N.A.	21079	45205 (Inner) 45206 (Outer)	41956 (2) (Cutaway)
158"	N.A.	●15838 (1994) (96-95 Exc. Calif.)	43207 ³	21079	45205 (Inner) 45206 (Outer)	41956 (2) (Cutaway)
176"	N.A.	●15838 (1994) (96-95 Exc. Calif.)	44084	21079	45205 (Inner) 45206 (Outer)	41956 (2) (Cutaway)

1996-92 8 CYL. E350 w/300 C.I.D. (4.9L) ENG. - 138", 158", 176" W.B.

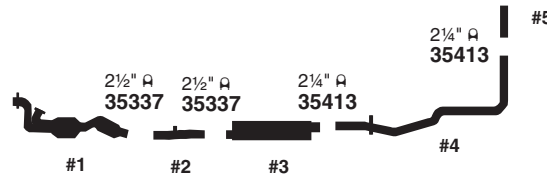

Part Code	#1	#2	#3	#4	#5
W.B.	Converter	Ext. Pipe	Muffler	Tail Pipe	Tail Pipe
138"	40634 ³⁷ (1996)	42846 (Cutaway) 43267 (Van, Wagon)	22000 (Reg. Duty) 22583 (Heavy Duty)	46774 (Cutaway) 46704 (Van, Wagon)	41956 (Cutaway)
158"	40634 ³⁷ (1996)	N.A. (Cutaway) 43267 (Van, Wagon)	22000 (Reg. Duty) 22583 (Heavy Duty)	46774 (Cutaway) 46704 (Van, Wagon)	41956 (Cutaway)
176"	40634 ³⁷ (1996)	N.A. (Cutaway) 43267 (Van, Wagon)	22000 (Reg. Duty) 22583 (Heavy Duty)	46774 (Cutaway) 46704 (Van, Wagon)	41956 (Cutaway)

● New number.
N.A. Not available.
3 Cut to required length.

37 Fed. & Calif. Emiss. Models. Not legal for use on OBDII vehicles licensed in the state of California.

**If welded assembly, replace all required parts.
WARNING: Reuse or replace O.E. Heat Shields.**

FORD SCHOOL BUS

1996-88 8 CYL. E350 w/351 C.I.D. (5.8L) ENG. - 158", 176" W.B.

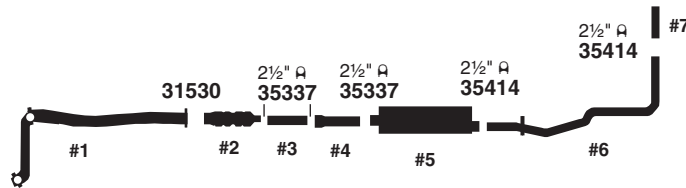

Part Code	#1	#2	#3	#4	#5	#6	#7
W.B.	Exhaust Pipe	Converter	Front Ext. Pipe	Rear Ext. Pipe	Muffler	Tail Pipe	Tail Pipe
158"	40587 (93-88) (w/o E4OD Trans.) 40588 (93-88) (w/E4OD Trans.)	15762 ⁴⁰³	N.A.	42984	22576	46776	41966 ³
176"	40587 (93-88) (w/o E4OD Trans.) 40588 (93-88) (w/E4OD Trans.)	15762 ⁴⁰³	42596 ³ (93-88) 43648 ³ (95-94)	42984	22576	46776	41966 ³

1995-88 8 CYL. E350 w/351 C.I.D. EFI ENG. - 138" W.B. (EXC. CUTAWAY) w/ELECTRONIC 4 SPEED AUTOMATIC OVERDRIVE TRANSMISSION (E4OD)

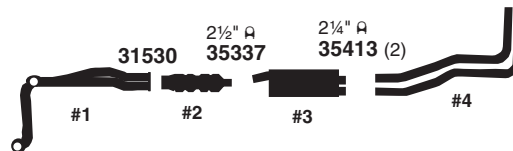

Part Code	#1	#2	#3	#4
W.B.	Exhaust Pipe	Converter	Muffler	Tail Pipe
138"	40588 (93-88)	15762 ⁴⁰³ (93-88)	44169 (Reg. Duty) 44701 (Heavy Duty)	45205 (Inner) 45206 (Outer)

1995-88 8 CYL. E350 w/351 C.I.D. ENG. - 138" W.B. CUTAWAY CHASSIS

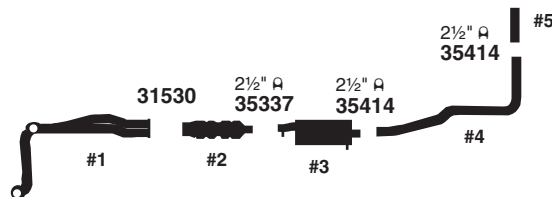

Part Code	#1	#2	#3	#4	#5
W.B.	Front Exhaust Pipe	Converter	Muffler	Tail Pipe	Tail Pipe
138"	40587 (93-88) (w/o E4OD Trans.) 40588 (93-88) (w/E4OD Trans.)	15762 ⁴⁰³ (93-88)	44263	44264	41966 ³

N.A. Not available.
 3 Cut to required length.
 403 Install supplied plug in front air tap for 89-88 models w/dual air tap.

**If welded assembly, replace all required parts.
 WARNING: Reuse or replace O.E. Heat Shields.**

INFORMATION & BUILD TO ORDER

TOOLS AND ACCESSORIES

SCHOOL BUS

MEDIUM DUTY TRUCK GVV 3-6

HEAVY DUTY TRUCK GVV 7-8

APPLICATION BY ENGINE

NOISE AND BACKPRESSURE DATA

TRACTOR

MUFFLER SPECS

O.E. CROSS INDEX

FORD SCHOOL BUS

1994-93 6 CYL. B600, B700 w/5.9L TURBO DIESEL, w/o CONVERTER

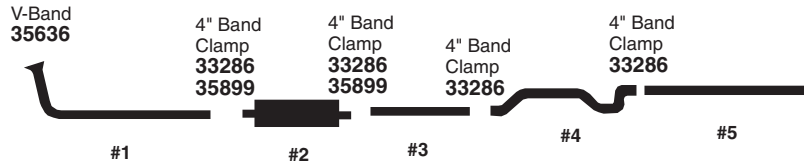

Part Code	#1	#2	#3	#4	#5
W.B.	Front Exhaust Pipe	Muffler	Ext. Pipe	Over Axle Pipe	Tail Pipe
151" - 275"	45375	22888	49161 ³	47700	44538

1994-80 8 CYL. B600, B700 w/370, 429 C.I.D. GAS ENG.

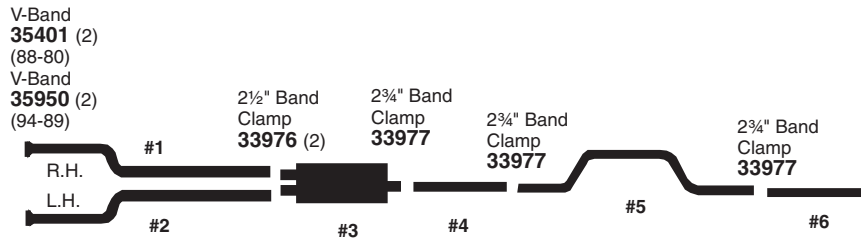

Part Code	#1	#2	#3	#4	#5	#6
W.B.	RH Front Exhaust Pipe	LH Front Exhaust Pipe	Muffler	Ext. Pipe	Over Axle Pipe	Tail Pipe
151" - 275"	44964@ (88-80) 44786# (88-80) 44158 (94-89)	40563 (88-80) 44159 (94-89)	22866 ⁴⁷	49050 ³	47570 (86-80) 47620 (94-87)	49050 ³

1993-91 8 CYL. E350 w/7.3L DIESEL ENG. - 138" W.B., FROM 6-91 (EXC. CUTAWAY)

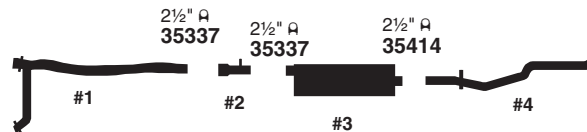

Part Code	#1	#2	#3	#4
W.B.	Front Exhaust Pipe	Rear Exhaust Pipe	Muffler	Tail Pipe
138"	40566	41590	22100 (Reg. Duty) 21475 (Heavy Duty)	45031

@ Stainless Steel.
Aluminized.
3 Cut to required length.

47 If new shield required, use (2) 35569 shields & (4) 35564 clamps.

**If welded assembly, replace all required parts.
WARNING: Reuse or replace O.E. Heat Shields.**

FORD SCHOOL BUS

1993-91 8 CYL. E350 w/7.3L DIESEL ENG., CUTAWAY CHASSIS - 138", 158", 176" W.B., FROM 6-91

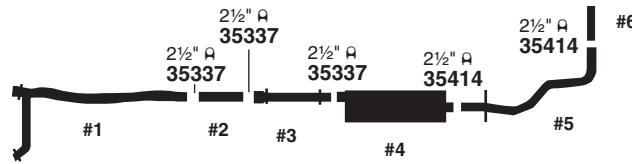

Part Code	#1	#2	#3	#4	#5	#6
W.B.	Exhaust Pipe	Front Ext. Pipe	Rear Ext. Pipe	Muffler	Tail Pipe	Tail Pipe
138"	40566	N.R.	41450	22100 (Reg. Duty) 21475 (Heavy Duty)	45268	41966 ³
158"	40566	N.R.	43242	22100 (Reg. Duty) 21475 (Heavy Duty)	45268	41966 ³
176"	40566	43729	43242	22100 (Reg. Duty) 21475 (Heavy Duty)	45268	41966 ³

1993-87 6 CYL. B600, B700 w/6.6L, 7.8L TURBO DIESEL

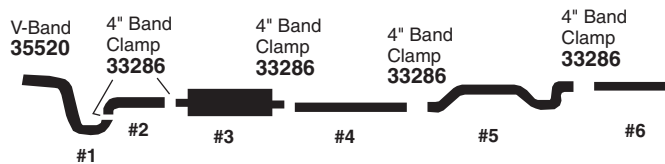

Part Code	#1	#2	#3	#4	#5	#6
W.B.	Front Exhaust Pipe	Ext. Pipe	Muffler	Ext. Pipe	Over Axle Pipe	Tail Pipe
151" - 255"	43277 (6.6L) 44315 (7.8L)	44095	22899	49161 ³	46736	49161 ³
275"	43277 (6.6L) 44315 (7.8L)	44095	22899	49052 ³	46736	49161 ³

1987-83 8 CYL. B600, B700 ALL MODELS w/8.2L TURBO DIESEL, MODELS BUILT AFTER 2-83

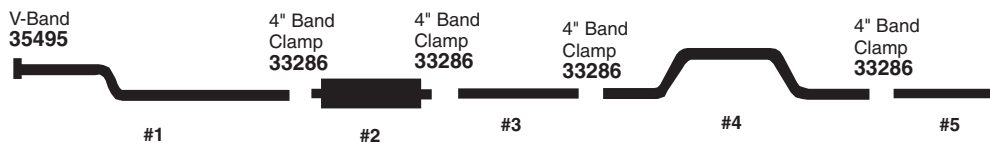

Part Code	#1	#2	#3	#4	#5
W.B.	Exhaust Pipe	Muffler	Ext. Pipe	Over Axle Pipe	Tail Pipe
151" - 275"	N.A.	22789	49052 ³	47621 (1987) N.A. (1986) 46637 (85-83)	49052 ³

N.A. Not available.
N.R. Not required.
3 Cut to required length.

**If welded assembly, replace all required parts.
WARNING: Reuse or replace O.E. Heat Shields.**

INFORMATION
& BUILD TO
ORDER

TOOLS AND
ACCESSORIES

SCHOOL BUS

MEDIUM
DUTY TRUCK
GVW 3-6

HEAVY DUTY
TRUCK
GVW 7-8

APPLICATION
BY ENGINE

NOISE AND
BACKPRESSURE
DATA

TRACTOR

MUFFLER
SPECS

O.E. CROSS
INDEX

FORD SCHOOL BUS

1987-83 8 CYL. B600, B700 ALL MODELS w/8.2L DIESEL, w/o TURBO —
MODELS BUILT AFTER 2-83

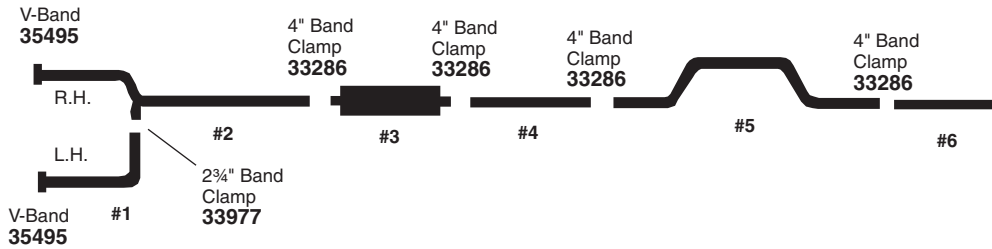

Part Code	#1	#2	#3	#4	#5	#6
W.B.	LH Exhaust Pipe	RH Exhaust Pipe	Muffler	Ext. Pipe	Over Axle Pipe	Tail Pipe
151" - 275"	43958	40400	22888	49052 ³	47621 (1987) N.A. (1986) 46637 (85-83)	49052 ³

1987-83 8 CYL. B600, B700 ALL MODELS w/CAT. 3208 (10.4L) TURBO DIESEL,
MODELS BUILT AFTER 2-83

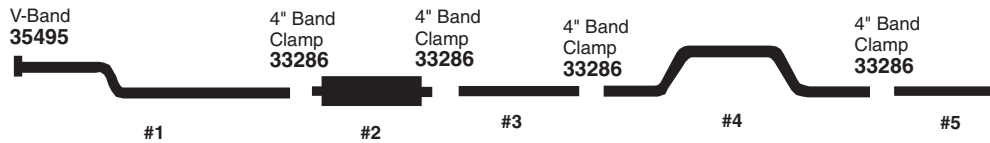

Part Code	#1	#2	#3	#4	#5
W.B.	Front Exhaust Pipe	Muffler	Ext. Pipe	Over Axle Pipe	Tail Pipe
151" - 275"	N.A.	22789	49052 ³	47621 (1987) N.A. (1986) 46637 (85-83)	49052 ³

1987-83 8 CYL. B600, B700 ALL MODELS w/CAT. 3208 (10.4L) w/o TURBO,
MODELS BUILT AFTER 2-83

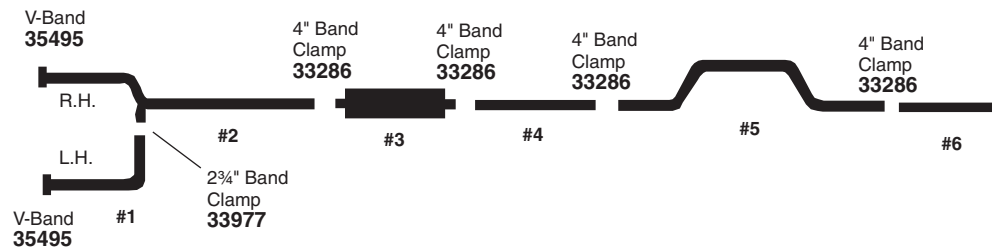

Part Code	#1	#2	#3	#4	#5	#6
W.B.	LH Exhaust Pipe	RH Exhaust Pipe	Muffler	Ext. Pipe	Over Axle Pipe	Tail Pipe
151" - 275"	N.A.	N.A.	22888	49052 ³	47621 (1987) N.A. (1986) 46637 (85-83)	49052 ³

N.A. Not available.
3 Cut to required length.

**If welded assembly, replace all required parts.
WARNING: Reuse or replace O.E. Heat Shields.**

FORD SCHOOL BUS

1983-80 8 CYL. B600, B700 ALL MODELS w/8.2L DIESEL, w/o TURBO, MODELS BUILT BEFORE 2-83

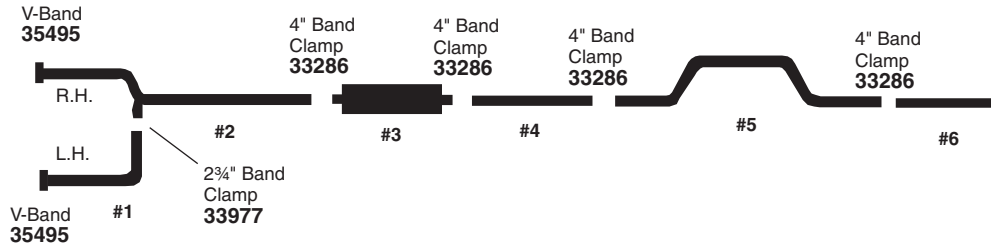

Part Code	#1	#2	#3	#4	#5	#6
W.B.	LH Exhaust Pipe	RH Exhaust Pipe	Muffler	Ext. Pipe	Over Axle Pipe	Tail Pipe
151" - 275"	43958	N.A.	22004	49052 ³	N.A.	49052 ³

1983-80 8 CYL. B600, B700 ALL MODELS w/8.2L TURBO DIESEL, MODELS BUILT BEFORE 2-83

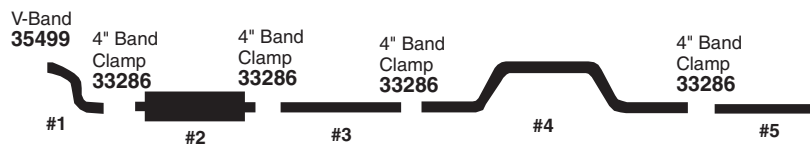

Part Code	#1	#2	#3	#4	#5
W.B.	Exhaust Pipe	Muffler	Ext. Pipe	Over Axle Pipe	Tail Pipe
151" - 275"	N.A.	22004	49052 ³	N.A.	49052 ³

FREIGHTLINER SCHOOL BUS

2003-02 6 CYL. FS65 MODEL w/900 MERCEDES DIESEL, AIR SUSPENSION

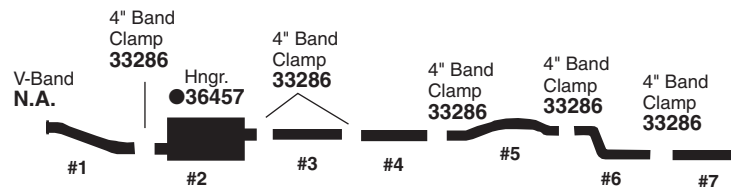

Part Code	#1	#2	#3	#4	#5	#6	#7
W.B.	Front Pipe	Muffler	Ext. Pipe		Over Axle Pipe	Over Axle Pipe	
			Front	Rear		Front	Rear
276"	●55478	22899	●56174	●56174	●56179	●55479	●56174

- New number.
- N.A. Not available.
- 3 Cut to required length.

**If welded assembly, replace all required parts.
WARNING: Reuse or replace O.E. Heat Shields.**

INFORMATION & BUILD TO ORDER

TOOLS AND ACCESSORIES

SCHOOL BUS

MEDIUM DUTY TRUCK GVV 3-6

HEAVY DUTY TRUCK GVV 7-8

APPLICATION BY ENGINE

NOISE AND BACKPRESSURE DATA

TRACTOR

MUFFLER SPECS

O.E. CROSS INDEX

FREIGHTLINER SCHOOL BUS

2002 6 CYL. FS65 MODEL w/CUMMINS 5.9L DIESEL, AIR SUSPENSION, HANDICAP PKG.

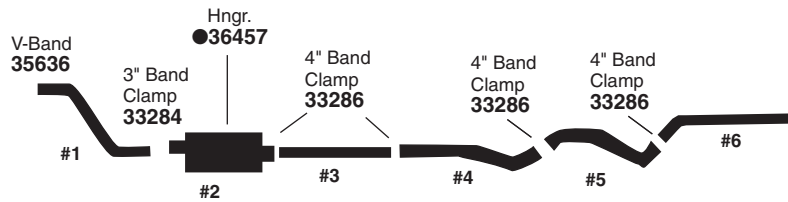

Part Code	#1	#2	#3	#4	#5	#6
W.B.	Front Exhaust Pipe	Muffler	Ext. Pipe	Over Axle Pipe		Tail Pipe
				Front	Rear	
215"	●54623	22991	●55475	●56173	54624	●48338

1999-98 6 CYL. F65 MODEL w/CUMMINS 5.9L DIESEL, AIR SUSPENSION

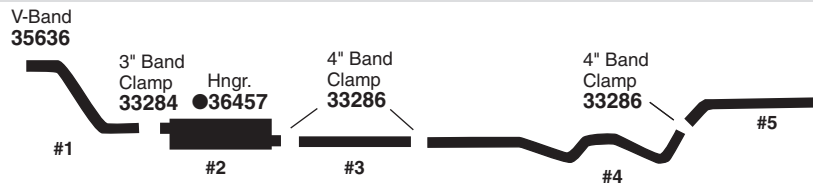

Part Code	#1	#2	#3	#4	#5
W.B.	Front Exhaust Pipe	Muffler	Ext. Pipe	Over Axle Pipe	Tail Pipe
150" - 276"	54168	22991	49214 ³	49234	49235

GENESIS SCHOOL BUS

1998-94 6 CYL. MODEL 3900 FRONT ENGINE CHASSIS w/DT466 DIESEL, RH TAIL PIPE, w/AIR SUSPENSION

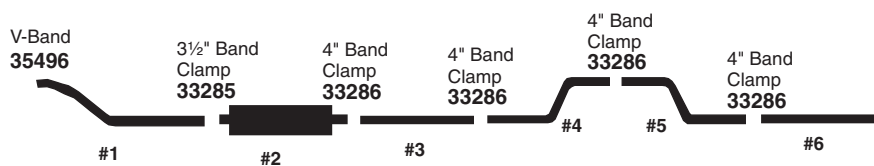

Part Code	#1	#2	#3	#4	#5	#6
W.B.	Front Exhaust Pipe	Muffler	Ext. Pipe	Over Axle Pipe		Tail Pipe
				Front	Rear	
152" - 276"	47744	22551	49165 ³	47645	45338 ⁴	49161 ^{3,4}

- New number.
- ³ Cut to required length.
- ⁴ O.E. Tail Pipe is one piece, Walker is two piece.

**If welded assembly, replace all required parts.
WARNING: Reuse or replace O.E. Heat Shields.**

GENESIS SCHOOL BUS

1998-94 6 CYL. MODEL 3900 FRONT ENGINE CHASSIS w/DT466 NGD DIESEL, w/o AIR SUSPENSION

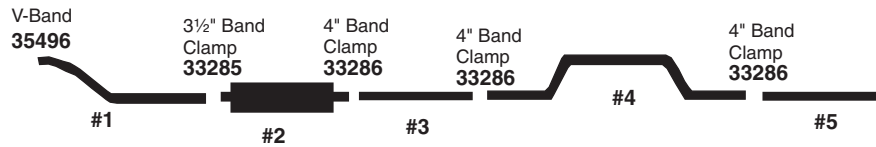

Part Code	#1	#2	#3	#4	#5
W.B.	Front Exhaust Pipe	Muffler	Rear Ext. Pipe	Over Axle Pipe	Tail Pipe
152" - 276"	47744	22551	49165 ³	46821 (LH Tail Pipe) 46588 (RH Tail Pipe)	49232

1994-92 6 CYL. MODEL 3900 FRONT ENGINE CHASSIS w/DT360 DIESEL, RH TAIL PIPE, w/AIR SUSPENSION

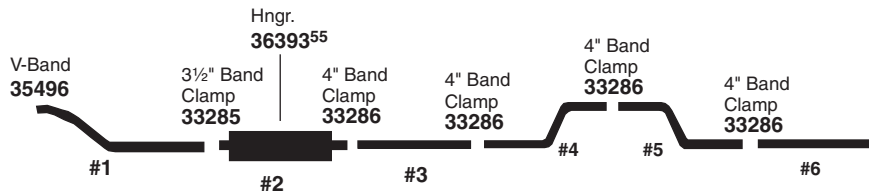

Part Code	#1	#2	#3	#4	#5	#6
W.B.	Front Exhaust Pipe	Muffler	Ext. Pipe	Over Axle Pipe		Tail Pipe
				Front	Rear	
152" - 276"	47704	22551	49165 ³	47645	45338	49161 ³

INTERNATIONAL SCHOOL BUS

2005-04 V8 CYL. MODEL IC w/VT365 DIESEL

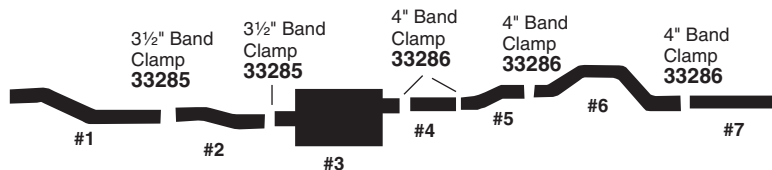

Part Code	#1	#2	#3	#4	#5	#6	#7
W.B.	Front Exhaust Pipe	Front Ext. Pipe	Converter Muffler	Ext. Pipe	Rear Ext. Pipe	Over Axle Pipe	Tail Pipe
All	●55472	●53637	N.A.	●51044	●53629	●55480	49161

● New number.
N.A. Not available.

³ Cut to required length.
⁵⁵ For accessories, see page 18.

**If welded assembly, replace all required parts.
WARNING: Reuse or replace O.E. Heat Shields.**

INFORMATION
& BUILD TO
ORDER

TOOLS AND
ACCESSORIES

SCHOOL BUS

MEDIUM
DUTY TRUCK
GVW 3-6

HEAVY DUTY
TRUCK
GVW 7-8

APPLICATION
BY ENGINE

NOISE AND
BACKPRESSURE
DATA

TRACTOR

MUFFLER
SPECS

O.E. CROSS
INDEX

INTERNATIONAL SCHOOL BUS

2004-01 6 CYL. SERIES 3800 w/T444, T444E TURBO DIESEL, w/AIR RIDE SUSPENSION

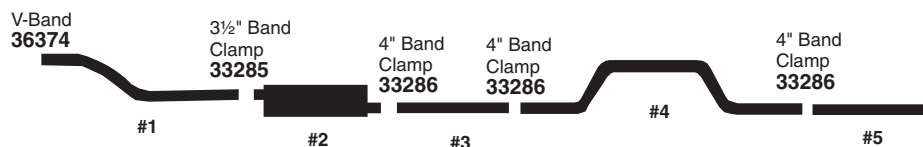

Part Code	#1	#2	#3	#4	#5
W.B.	Front Exhaust Pipe	Muffler	Ext. Pipe	Over Axle Pipe	Tail Pipe
All	55159	22551	49165 ³	47766	49238 ³

2001 6 CYL. SERIES 3800 w/444 TURBO DIESEL, w/SPRING SUSPENSION (VARI-RATE SUSPENSION)

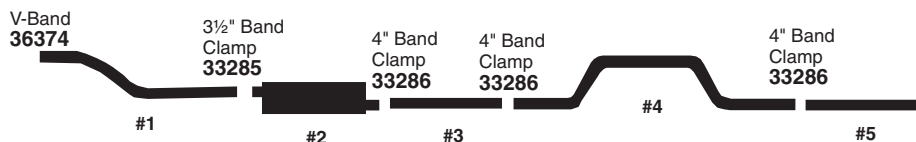

Part Code	#1	#2	#3	#4	#5
W.B.	Front Exhaust Pipe	Muffler	Ext. Pipe	Over Axle Pipe	Tail Pipe
All	55159	22551	49165 ³	56025	49151 ³

2001-00 6 CYL. SERIES 3800 w/466 TURBO DIESEL, w/AIR RIDE SUSPENSION

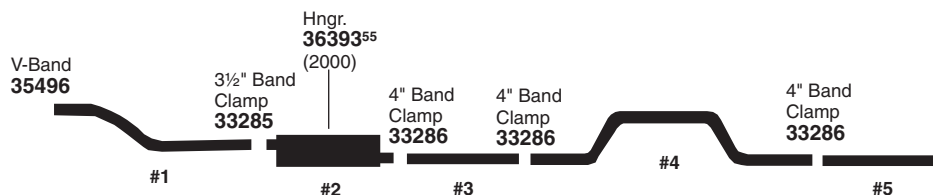

Part Code	#1	#2	#3	#4	#5
W.B.	Front Exhaust Pipe	Muffler	Ext. Pipe	Over Axle Pipe	Tail Pipe
All	55063	22551	49165 ³	47766	49238 ³

³ Cut to required length.
⁵⁵ For accessories, see page 18.

**If welded assembly, replace all required parts.
 WARNING: Reuse or replace O.E. Heat Shields.**

INTERNATIONAL SCHOOL BUS

2001-99 6 CYL. SERIES 3800 w/466 TURBO DIESEL, w/SPRING SUSPENSION (VARI-RATE SUSPENSION)

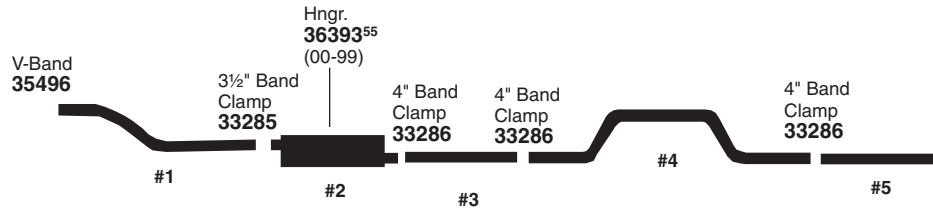

Part Code	#1	#2	#3	#4	#5
W.B.	Front Exhaust Pipe	Muffler	Ext. Pipe	Over Axle Pipe	Tail Pipe
All	55063	22551	49165 ³	46588 (1999) 56025 (01-00)	49151 ³

2000-99 6 CYL. SERIES 3800 w/T444E TURBO DIESEL w/AIR RIDE SUSPENSION



Part Code	#1	#2	#3	#4	#5
W.B.	Front Exhaust Pipe	Muffler	Ext. Pipe	Over Axle Pipe	Tail Pipe
All	55158 (2000)	22551	49165 ³	47765	49166 ³

2000-99 6 CYL. SERIES 3800 w/T444E TURBO DIESEL, w/SPRING SUSPENSION (VARI-RATE SUSPENSION)

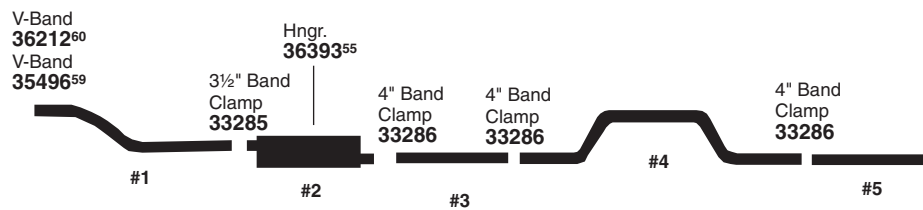

Part Code	#1	#2	#3	#4	#5
W.B.	Front Exhaust Pipe	Muffler	Ext. Pipe	Over Axle Pipe	Tail Pipe
All	55158 ⁶⁰ 55209 ⁵⁹	22551	49165 ³	46821 (LH Routing) 46588 (RH Routing)	49151 ³

³ Cut to required length.

⁵⁵ For accessories, see page 18.

⁵⁹ Models w/Allison MTB643 Auto. Trans.

⁶⁰ Models w/o Allison MTB643 Auto. Trans.

**If welded assembly, replace all required parts.
WARNING: Reuse or replace O.E. Heat Shields.**

INFORMATION & BUILD TO ORDER

TOOLS AND ACCESSORIES

SCHOOL BUS

MEDIUM DUTY TRUCK GVV 3-6

HEAVY DUTY TRUCK GVV 7-8

APPLICATION BY ENGINE

NOISE AND BACKPRESSURE DATA

TRACTOR

MUFFLER SPECS

O.E. CROSS INDEX

INTERNATIONAL SCHOOL BUS

2000-96 6 CYL. SERIES 3800 w/DT408, DT466 NGD DIESEL, w/CODE 07ABC, RH EXHAUST, 152" W.B.

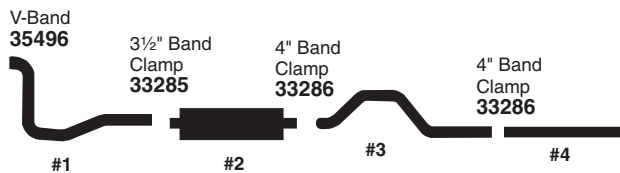

Part Code	#1	#2	#3	#4
W.B.	Front Exhaust Pipe	Conv./Muffler	Over Axle Pipe	Tail Pipe
152"	55063	N.A.	N.A.	49151 ³

2000-94 6 CYL. SERIES 3600 w/T444E DIESEL, w/CODE 10NXW-HANDICAP PKG., RH REAR EXIT TAIL PIPE

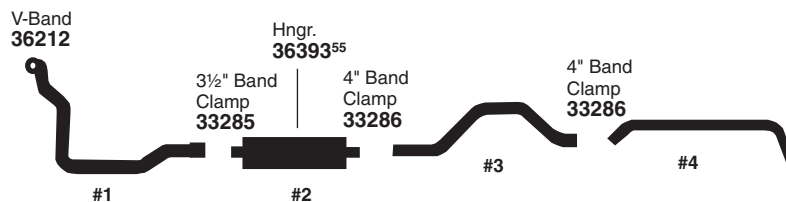

Part Code	#1	#2	#3	#4
W.B.	Front Exhaust Pipe	Muffler	Over Axle Pipe	Tail Pipe
152" - 276"	55057	22551 (w/o Converter)	N.A. (w/o Air Suspension) 47727 (w/Air Suspension)	49166 ³ (w/o Air Suspension) 49151 ³ (w/Air Suspension)

N.A. Not available.
³ Cut to required length.
⁵⁵ For accessories, see page 18.

**If welded assembly, replace all required parts.
 WARNING: Reuse or replace O.E. Heat Shields.**

INTERNATIONAL SCHOOL BUS

2000-94 6 CYL. SERIES 3600, 3800 w/DT408, DT466E, T444E DIESEL w/AIR SUSPENSION

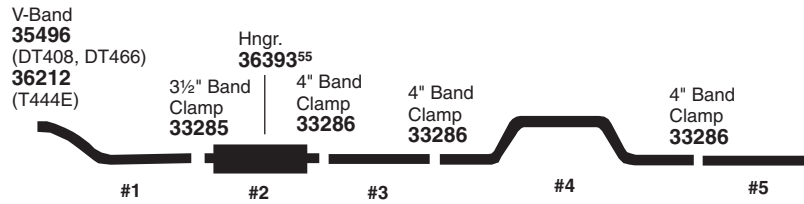

Part Code	#1	#2	#3	#4	#5
W.B.	Front Exhaust Pipe	Muffler	Ext. Pipe	Over Axle Pipe	Tail Pipe
152"	55057 (T444E) 55063 ⁶⁰ (DT408, DT466E) N.A. ⁵⁹ (DT408, DT466E)	22551 (w/o Converter)	N.A.	47645	49166 ³ (RH Routing) 49177 ³ (LH Routing)
170" - 276"	55057 (T444E) 55063 ⁶⁰ (DT408, DT466E) N.A. ⁵⁹ (DT408, DT466E)	22551 (w/o Converter)	49165 ³	47645	49166 ³ (RH Routing) 49177 ³ (LH Routing)

2000-94 6 CYL. SERIES 3600, 3800 w/DT408, DT466E, T444E TURBO DIESEL, w/VARI-RATE SUSPENSION

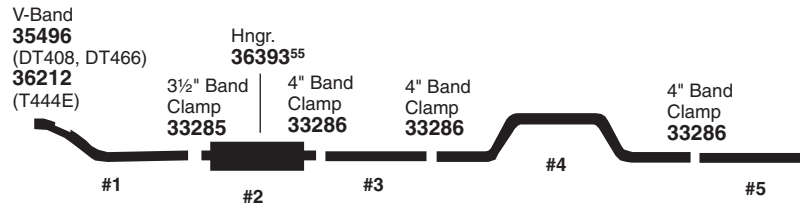

Part Code	#1	#2	#3	#4	#5
W.B.	Front Exhaust Pipe	Muffler	Ext. Pipe	Over Axle Pipe	Tail Pipe
152"	55057 (T444E) 55063 (DT408, DT466E)	22551 (w/o Converter)	N.A.	46821 (LH Routing) 46588 (RH Routing)	49151 ³
170" - 276"	55057 (T444E) 55063 (DT408, DT466E)	22551 (w/o Converter)	49165 ³	46821 (LH Routing) 46588 (RH Routing)	49151 ³

N.A. Cut to required length.
 3 Cut to required length.
 55 For accessories, see page 18.

59 Models w/Allison MTB643 Auto. Trans.
 60 Models w/o Allison MTB643 Auto. Trans.

**If welded assembly, replace all required parts.
 WARNING: Reuse or replace O.E. Heat Shields.**

INFORMATION & BUILD TO ORDER
 TOOLS AND ACCESSORIES
 SCHOOL BUS
 MEDIUM DUTY TRUCK GVV 3-6
 HEAVY DUTY TRUCK GVV 7-8
 APPLICATION BY ENGINE
 NOISE AND BACKPRESSURE DATA
 TRACTOR
 MUFFLER SPECS
 O.E. CROSS INDEX

INTERNATIONAL SCHOOL BUS

2000-94 6 CYL. SERIES 3600, 3800 w/DT408, DT466E, T444E DIESEL, w/MOR-RYDE SUSPENSION (EXC. RH REAR EXIT TAIL PIPE)

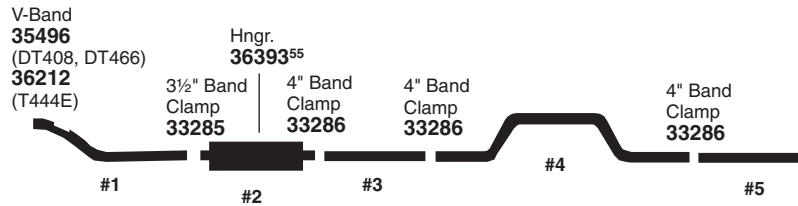

Part Code	#1	#2	#3	#4	#5
W.B.	Front Exhaust Pipe	Muffler	Ext. Pipe	Over Axle Pipe	Tail Pipe
152"	55057 (T444E) 55063 (DT408, DT466E)	22551 (w/o Converter)	N.A.	46588	49151 ³
170" - 276"	55057 (T444E) 55063 (DT408, DT466E)	22551 (w/o Converter)	49165 ³	46588	49151 ³

2000-94 6 CYL. SERIES 3800 w/DT408, T444E, DT466E TURBO DIESEL, CODE 07AAS, TAIL PIPE EXITS FRONT OF LH REAR WHEEL

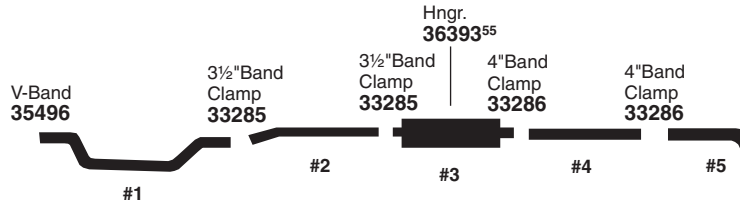

Part Code	#1	#2	#3	#4	#5
W.B.	Exhaust Pipe	Front Ext. Pipe	Muffler	Rear Ext. Pipe	Tail Pipe
152" - 276"	N.A.	N.A. (152" W.B.) 44250 ³ (193 - 276" W.B.)	22551 (w/o Converter)	49161 ³	44449 ³

2000-94 6 CYL. SERIES 3800 w/DT408, DT466E TURBO DIESEL, CODE 07AAN LH EXIT TAIL PIPE, w/o AIR SUSPENSION

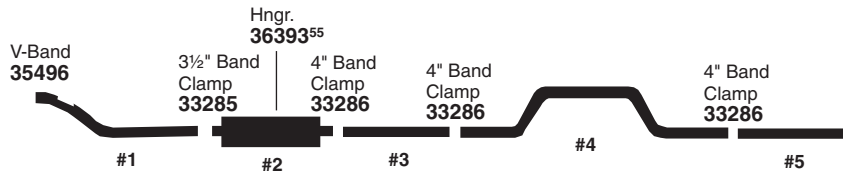

Part Code	#1	#2	#3	#4	#5
W.B.	Front Exhaust Pipe	Muffler	Ext. Pipe	Over Axle Pipe	Tail Pipe
152"	55063	22551 (w/o Converter)	—	47729	49151 ³
170" - 276"	55063	22551 (w/o Converter)	49165 ³	46821	49151 ³

N.A. Not available.
3 Cut to required length.

55 For accessories, see page 18.

**If welded assembly, replace all required parts.
WARNING: Reuse or replace O.E. Heat Shields.**

INTERNATIONAL SCHOOL BUS

2000-94 6 CYL. SERIES 3800 w/DT408, DT466E TURBO DIESEL, CODE 07AAW, w/ALLISON MTB643, MTB653DR AUTO. TRANS., LH EXIT TAIL PIPE, w/o AIR SUSPENSION

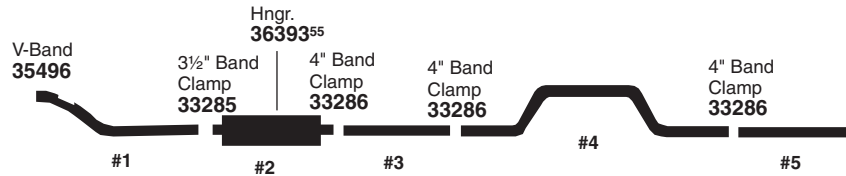

Part Code	#1	#2	#3	#4	#5
W.B.	Front Exhaust Pipe	Muffler	Ext. Pipe	Over Axle Pipe	Tail Pipe
152"	N.A.	22551 (w/o Converter)	—	N.A.	49151 ³
170" - 276"	N.A.	22551 (w/o Converter)	N.A. (170" W.B.) 49165 (193" - 276" W.B.)	46821	49151 ³

1999 6 CYL. SERIES 3800 w/466 TURBO DIESEL, w/AIR RIDE SUSPENSION

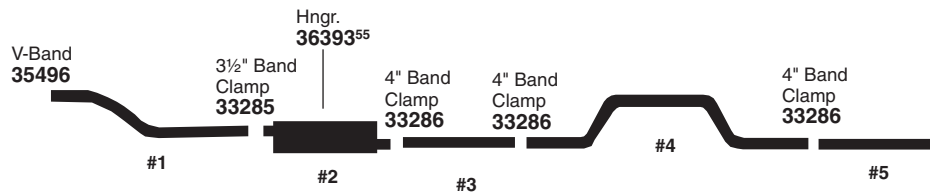

Part Code	#1	#2	#3	#4	#5
W.B.	Front Exhaust Pipe	Muffler	Ext. Pipe	Over Axle Pipe	Tail Pipe
All	55063	22551	49165 ³	47765	49166 ³

1993-91 6 CYL. SERIES 3700/3800 w/DT/DTA360 TURBO DIESEL, LH SIDE MOUNTED, SIDE EXIT TAIL PIPE FRONT OF REAR WHEEL

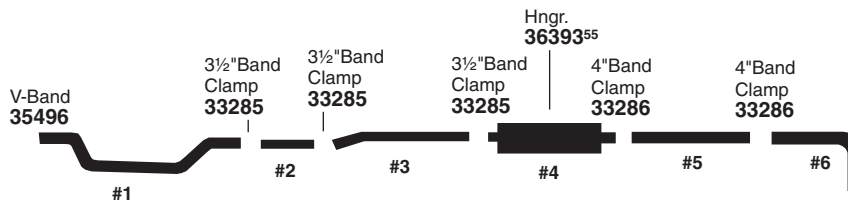

Part Code	#1	#2	#3	#4	#5	#6
W.B.	Exhaust Pipe	Flex Tubing	Front Ext. Pipe	Muffler	Rear Ext. Pipe	Tail Pipe
152" - 276"	N.A.	42066 ^{3,56}	N.A.	22551	49161 ³	44449 ³

N.A. Not available.
3 Cut to required length.

55 For accessories, see page 18.
56 For Flex Tubing options, see page 27.

**If welded assembly, replace all required parts.
WARNING: Reuse or replace O.E. Heat Shields.**

INFORMATION & BUILD TO ORDER

TOOLS AND ACCESSORIES

SCHOOL BUS

MEDIUM DUTY TRUCK GVV 3-6

HEAVY DUTY TRUCK GVV 7-8

APPLICATION BY ENGINE

NOISE AND BACKPRESSURE DATA

TRACTOR

MUFFLER SPECS

O.E. CROSS INDEX

INTERNATIONAL SCHOOL BUS

1993-91 6 CYL. SERIES 3700/3800 w/DT/DTA360 TURBO DIESEL, w/AIR SUSPENSION, FROM 12-10-90

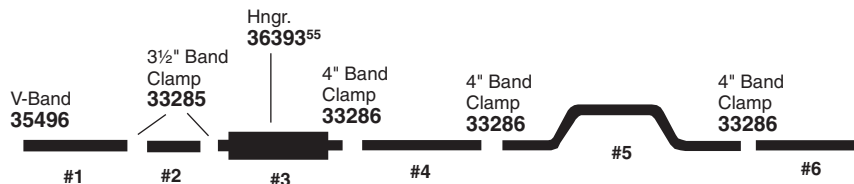

Part Code	#1	#2	#3	#4	#5	#6
W.B.	Front Exhaust Pipe	Front Ext. Pipe	Muffler	Rear Ext. Pipe	Over Axle Pipe	Tail Pipe
152"	45076 (DT360) 44347 (DTA360)	N.R. (DT360) 42066 ^{3,56} (DTA360)	22551	N.A.	47645	49166 (RH Tail Pipe) 49177 (LH Tail Pipe)
170"	45076 (DT360) 44347 (DTA360)	N.R. (DT360) 42066 ^{3,56} (DTA360)	22551	N.A.	47645	49166 (RH Tail Pipe) 49177 (LH Tail Pipe)
193" - 276"	45076 (DT360) 44347 (DTA360)	N.R. (DT360) 42066 ^{3,56} (DTA360)	22551	49165 ³	47645	49166 (RH Tail Pipe) 49177 (LH Tail Pipe)

1993-91 6 CYL. SERIES 3700/3800 w/DT/DTA466 TURBO DIESEL, LH SIDE MOUNTED, SIDE EXIT TAIL PIPE FRONT OF REAR WHEEL

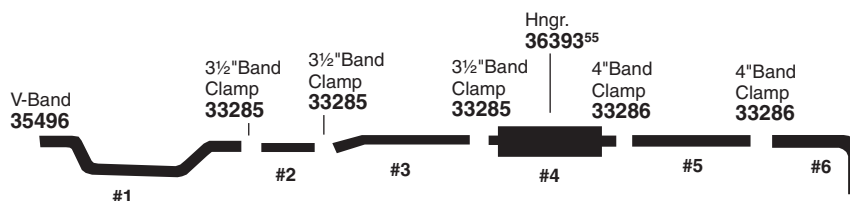

Part Code	#1	#2	#3	#4	#5	#6
W.B.	Exhaust Pipe	Flex Tubing	Front Ext. Pipe	Muffler	Rear Ext. Pipe	Tail Pipe
152" - 170"	N.A.	42066 ^{3,56}	N.A.	22551	49161 ³	44449 ³
193" - 276"	N.A.	42066 ^{3,56}	44250	22551	49161 ³	44449 ³

N.A. Not available.
N.R. Not required.
3 Cut to required length.

55 For accessories, see page 18.
56 For Flex Tubing options, see page 27.

**If welded assembly, replace all required parts.
WARNING: Reuse or replace O.E. Heat Shields.**

INTERNATIONAL SCHOOL BUS

1993-91 6 CYL. SERIES 3700/3800 w/DT/DTA466 TURBO DIESEL, w/AIR SUSPENSION, FROM 12-10-90

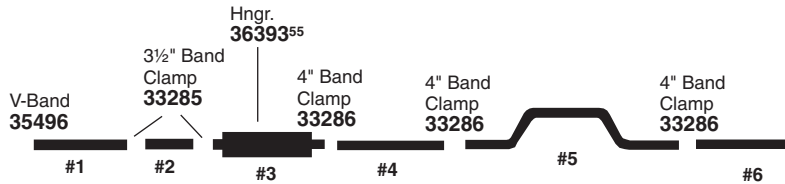

Part Code	#1	#2	#3	#4	#5	#6
W.B.	Front Exhaust Pipe	Front Ext. Pipe	Muffler	Rear Ext. Pipe	Over Axle Pipe	Tail Pipe
152"	44347 ^{58,59}	42066 ^{3,56}	22551	N.A.	47645	49166 ³ (RH Tail Pipe) 49177 ³ (LH Tail Pipe)
170"	44347 ^{58,59}	42066 ^{3,56}	22551	N.A.	47645	49166 ³ (RH Tail Pipe) 49177 ³ (LH Tail Pipe)
193" - 276"	44347 ^{58,59}	42066 ^{3,56}	22551	49165 ³	47645	49166 ³ (RH Tail Pipe) 49177 ³ (LH Tail Pipe)

1993-91 6 CYL. SERIES 3700/3800 w/DT/DTA466 TURBO DIESEL, w/VARI-RATE SUSPENSION, FROM 12-10-90

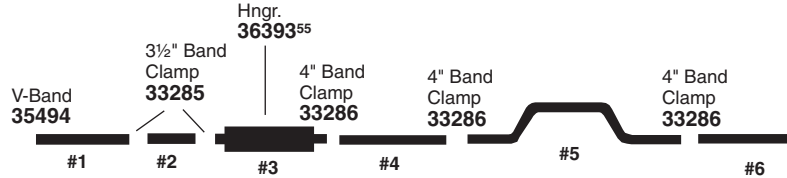

Part Code	#1	#2	#3	#4	#5	#6
W.B.	Front Exhaust Pipe	Front Ext. Pipe	Muffler	Rear Ext. Pipe	Over Axle Pipe	Tail Pipe
152"	44347 ^{58,59}	42066 ^{3,56}	22551	N.A.	46588 (RH Tail Pipe) 46821 (LH Tail Pipe)	49151 ³
170"	44347 ^{58,59}	42066 ^{3,56}	22551	N.A.	46588 (RH Tail Pipe) 46821 (LH Tail Pipe)	49151 ³
193" - 276"	44347 ^{58,59}	42066 ^{3,56}	22551	49165 ³	46588 (RH Tail Pipe) 46821 (LH Tail Pipe)	49151 ³

N.A. Not available.
 3 Cut to required length.
 55 For accessories, see page 18.

56 For Flex Tubing options, see page 27.
 58 Drill hole in fitting for pyrometer applications.
 59 Models w/Allison MTB643 Auto. Trans.

**If welded assembly, replace all required parts.
 WARNING: Reuse or replace O.E. Heat Shields.**

INFORMATION & BUILT TO ORDER
 TOOLS AND ACCESSORIES
 SCHOOL BUS
 MEDIUM DUTY TRUCK GVV 3-6
 HEAVY DUTY TRUCK GVV 7-8
 APPLICATION BY ENGINE
 NOISE AND BACKPRESSURE DATA
 TRACTOR
 MUFFLER SPECS
 O.E. CROSS INDEX

INTERNATIONAL SCHOOL BUS

1993-91 6 CYL. SERIES 3700/3800 w/DT/DTA466 TURBO DIESEL, w/MOR-RYDE SUSPENSION, LH EXIT TAIL PIPE

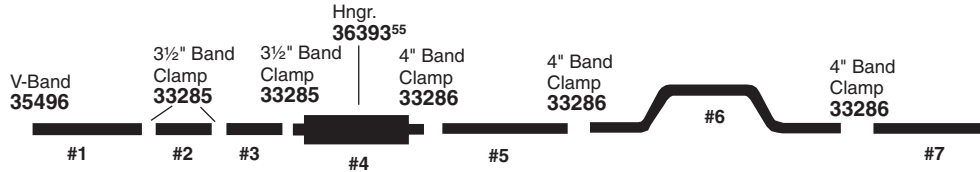

Part Code	#1	#2	#3	#4	#5	#6	#7
W.B.	Front Exhaust Pipe	Flex Tubing	Front Ext. Pipe	Muffler	Rear Ext. Pipe	Over Axle Pipe	Tail Pipe
152"	44347 ^{58,59}	42066 ^{3,56}	N.A.	22551	N.A.	46821	49151 ³
170"	44347 ^{58,59}	42066 ^{3,56}	N.A.	22551	N.A.	46821	49151 ³
193" - 276"	44347 ^{58,59}	42066 ^{3,56}	N.A.	22551	49165 ³	46821	49151 ³

1993-91 6 CYL. SERIES 3900FC w/DT/DTA360, 466 TURBO DIESEL, w/REAR EXIT TAIL PIPE w/AIR SUSPENSION

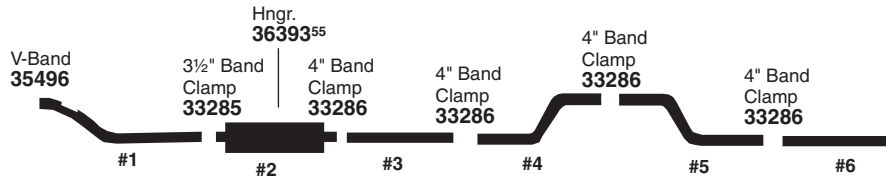

Part Code	#1	#2	#3	#4	#5	#6
W.B.	Front Exhaust Pipe	Muffler	Ext. Pipe	Over Axle Pipe		Tail Pipe
				Front	Rear	
152" - 276"	47704 (DT/DTA360) 47706 (DT/DTA466)	22551	49165 ³	47645	N.A. (LH Routing) 45338 (RH Routing)	49177 ³ (LH Routing) 49161 ³ (RH Routing)

1993-91 6 CYL. SERIES 3900FC w/DT/DTA360, 466 TURBO DIESEL, w/REAR EXIT TAIL PIPE w/o AIR SUSPENSION

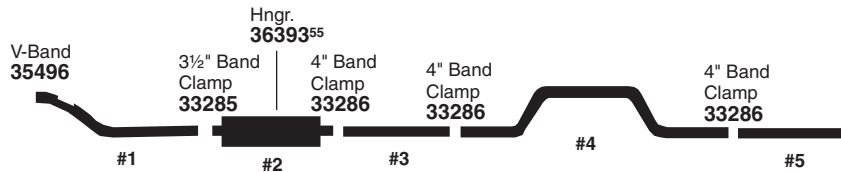

Part Code	#1	#2	#3	#4	#5
W.B.	Front Exhaust Pipe	Muffler	Ext. Pipe	Over Axle Pipe	Tail Pipe
152" - 276"	47704 (DT/DTA360) 47706 (DT/DTA466)	22551	49165 ³	46821 (LH Routing) 46588 (RH Routing)	49151 ³

N.A. Not available.
3 Cut to required length.
55 For accessories, see page 18.

56 For Flex Tubing options, see page 27.
58 Drill hole in fitting for pyrometer applications.
59 Models w/Allison MTB643 Auto. Trans.

**If welded assembly, replace all required parts.
WARNING: Reuse or replace O.E. Heat Shields.**

INTERNATIONAL SCHOOL BUS

1993-91 6 CYL. SERIES 3900FC w/DT/DTA360, 466 TURBO DIESEL, RH SIDE EXHAUST, SIDE EXIT FRONT OF WHEEL

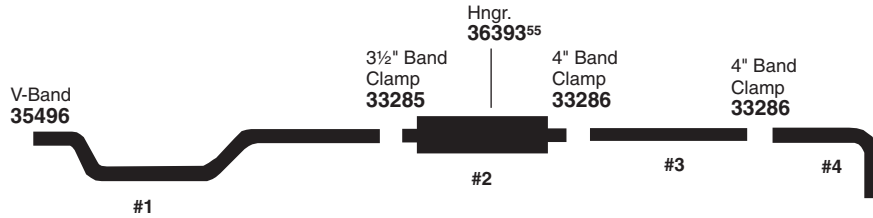

Part Code	#1	#2	#3	#4
W.B.	Front Exhaust Pipe	Muffler	Ext. Pipe	Tail Pipe
152"	47704 (DT/DTA360) 47706 (DT/DTA466)	22551	N.A.	44449 ³
170" - 276"	47704 (DT/DTA360) 47706 (DT/DTA466)	22551	49165 ³	44449 ³

1993-91 6 CYL. SERIES 3900FC w/DT/DTA360, 466 TURBO DIESEL, LH MOUNTED EXHAUST, SIDE EXIT FRONT OF REAR TIRE

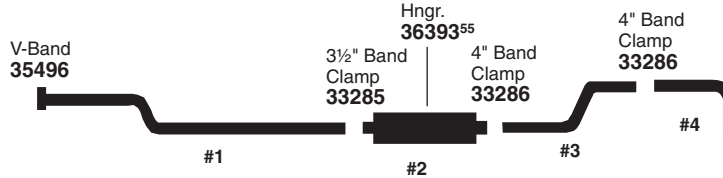

Part Code	#1	#2	#3	#4
W.B.	Front Exhaust Pipe	Muffler	Ext. Pipe	Tail Pipe
152"	47704 (DT/DTA360) 47706 (DT/DTA466)	22551	N.A.	46820
170" - 276"	47704 (DT/DTA360) 47706 (DT/DTA466)	22551	49165 ³	46820

1993-88 6 CYL. SERIES 3700/3800 w/7.3L DIESEL, LH SIDE EXIT IN FRONT OF REAR WHEEL

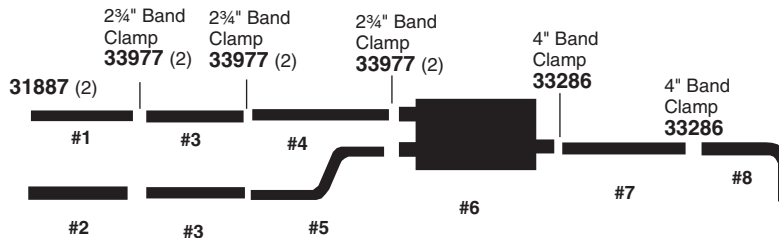

Part Code	#1	#2	#3	#4	#5	#6	#7	#8
W.B.	RH Front Exhaust Pipe	LH Front Exhaust Pipe	Flex Tubing	RH Rear Ext. Pipe	LH Rear Ext. Pipe	Muffler	Ext. Pipe	Tail Pipe
152" - 276"	N.A.	N.A.	49044 ³	N.A.	N.A.	22231	49165 ³	44449 ³

N.A. Not available.
³ Cut to required length.
⁵⁵ For accessories, see page 18.

**If welded assembly, replace all required parts.
 WARNING: Reuse or replace O.E. Heat Shields.**

INFORMATION & BUILD TO ORDER
 TOOLS AND ACCESSORIES
 SCHOOL BUS
 MEDIUM DUTY TRUCK GVV 3-6
 HEAVY DUTY TRUCK GVV 7-8
 APPLICATION BY ENGINE
 NOISE AND BACKPRESSURE DATA
 TRACTOR
 MUFFLER SPECS
 O.E. CROSS INDEX

INTERNATIONAL SCHOOL BUS

1993-88 6 CYL. SERIES 3600/3700 w/7.3L DIESEL, LH SIDE EXIT TAIL PIPE

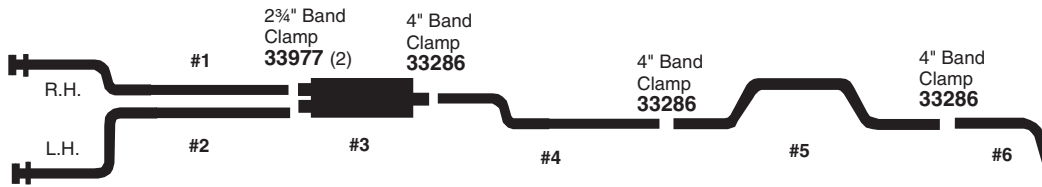

Part Code	#1	#2	#3	#4	#5	#6
W.B.	RH Front Exhaust Pipe	LH Front Exhaust Pipe	Muffler	Ext. Pipe	Over Axle Pipe	Tail Pipe
152"	46670	44154	22231	N.A.	46821 (w/o Air Suspension)	49151 ³ (w/o Air Suspension) 49177 ³ (w/Air Suspension)
170"	46670	44154	22231	N.A.	46821 (w/o Air Suspension)	49151 ³ (w/o Air Suspension) 49177 ³ (w/Air Suspension)
193" - 276"	46670	44154	22231	49052 ³	46821 (w/o Air Suspension)	49151 ³ (w/o Air Suspension) 49177 ³ (w/Air Suspension)

1993-88 6 CYL. SERIES 3600/3700 w/7.3L DIESEL, RH SIDE EXIT TAIL PIPE

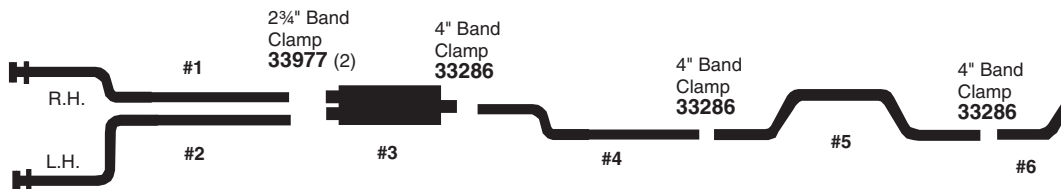

Part Code	#1	#2	#3	#4	#5	#6
W.B.	RH Front Exhaust Pipe	LH Front Exhaust Pipe	Muffler	Ext. Pipe	Over Axle Pipe	Tail Pipe
152"	46670	44154	22231	N.A.	46588 (w/o Air Suspension) 47645 (w/Air Suspension)	49151 ³ (w/o Air Suspension) 49166 ³ (w/Air Suspension)
170"	46670	44154	22231	N.A.	46588 (w/o Air Suspension) 47645 (w/Air Suspension)	49151 ³ (w/o Air Suspension) 49166 ³ (w/Air Suspension)
193" - 276"	46670	44154	22231	49165 ³	46588 (w/o Air Suspension) 47645 (w/Air Suspension)	49151 ³ (w/o Air Suspension) 49166 ³ (w/Air Suspension)

N.A. Not available.
3 Cut to required length.

**If welded assembly, replace all required parts.
WARNING: Reuse or replace O.E. Heat Shields.**

INTERNATIONAL SCHOOL BUS

1993-88 6 CYL. SERIES 3600/3700/3800 w/DT/DTA360 TURBO DIESEL, w/MOR-RYDE SUSPENSION, LH REAR EXIT TAIL PIPE (EXC. ALLISON MTB643 AUTO. TRANS.)

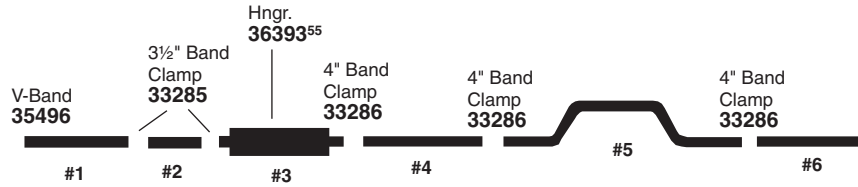

Part Code	#1	#2	#3	#4	#5	#6
W.B.	Front Exhaust Pipe	Front Ext. Pipe	Muffler	Rear Ext. Pipe	Over Axle Pipe	Tail Pipe
152"	45076 (DT360) 44347 (DTA360)	N.R. (DT360) 42066 ^{3,56} (DTA360)	22551	N.A.	46821	49151 ³
170"	45076 (DT360) 44347 (DTA360)	N.R. (DT360) 42066 ^{3,56} (DTA360)	22551	N.A.	46821	49151 ³
193" - 276"	45076 (DT360) 44347 (DTA360)	N.R. (DT360) 42066 ^{3,56} (DTA360)	22551	49165 ³	46821	49151 ³

1993-88 6 CYL. SERIES 3600/3700/3800 w/DT/DTA360 TURBO DIESEL, w/VARI-RATE SUSPENSION (EXC. ALLISON MTB643 AUTO. TRANS.)

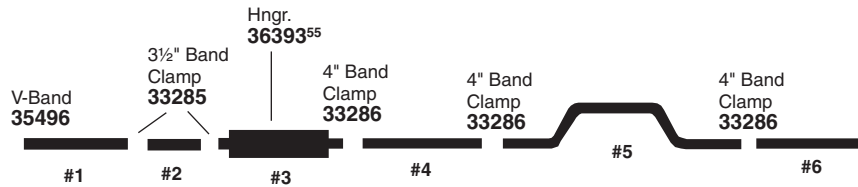

Part Code	#1	#2	#3	#4	#5	#6
W.B.	Front Exhaust Pipe	Front Ext. Pipe	Muffler	Rear Ext. Pipe	Over Axle Pipe	Tail Pipe
152"	45076 (DT360) 44347 (DTA360)	N.R. (DT360) 42066 ^{3,56} (DTA360)	22551	N.A.	46588 (RH Tail Pipe) 46821 (LH Tail Pipe)	49151 ³
170"	45076 (DT360) 44347 (DTA360)	N.R. (DT360) 42066 ^{3,56} (DTA360)	22551	N.A.	46588 (RH Tail Pipe) 46821 (LH Tail Pipe)	49151 ³
193" - 276"	45076 (DT360) 44347 (DTA360)	N.R. (DT360) 42066 ^{3,56} (DTA360)	22551	49165 ³	46588 (RH Tail Pipe) 46821 (LH Tail Pipe)	49151 ³

N.A. Not available.
 N.R. Not required.
 3 Cut to required length.

55 For accessories, see page 18.
 56 For Flex Tubing options, see page 27.

**If welded assembly, replace all required parts.
 WARNING: Reuse or replace O.E. Heat Shields.**

INFORMATION & BUILD TO ORDER

TOOLS AND ACCESSORIES

SCHOOL BUS

MEDIUM DUTY TRUCK
GVW 3-6

HEAVY DUTY TRUCK
GVW 7-8

APPLICATION BY ENGINE

NOISE AND BACKPRESSURE DATA

TRACTOR

MUFFLER SPECS

O.E. CROSS INDEX

INTERNATIONAL SCHOOL BUS

1991-88 6 CYL. SERIES 3600/3700/3800 w/DT/DTA360 (5.9L) DIESEL ENG. , w/AIR SUSPENSION, RH EXIT TAIL PIPE (EXC. ALLISON MTB643 TRANSMISSION, BUILT BEFORE 12-10-90)

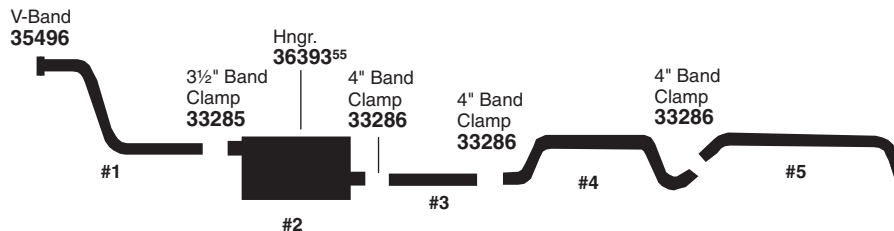

Part Code	#1	#2	#3	#4	#5
W.B.	Front Exhaust Pipe	Muffler	Ext. Pipe	Over Axle Pipe	Tail Pipe
152"	45076 ³	22551	N.A.	47645	49166 ³
170"	45076 ³	22551	N.A.	47645	49166 ³
193" - 276"	45076 ³	22551	49165 ³	47645	49166 ³

1991-88 6 CYL. SERIES 3600/3700/3800 w/DT/DTA360 (5.9L) DIESEL ENG., w/o AIR SUSPENSION, LH EXIT TAIL PIPE (EXC. ALLISON MTB643 TRANSMISSION, BUILT BEFORE 12-10-90)

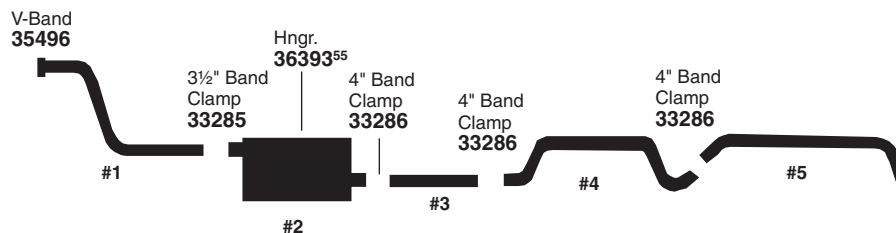

Part Code	#1	#2	#3	#4	#5
W.B.	Front Exhaust Pipe	Muffler	Ext. Pipe	Over Axle Pipe	Tail Pipe
152"	45076 ³	22551	N.A.	46588	49177 ³
170" - 276"	45076 ³	22551	49165 ³	46588	49177 ³

N.A. Not available.
 3 Cut to required length.
 55 For accessories, see page 18.

**If welded assembly, replace all required parts.
 WARNING: Reuse or replace O.E. Heat Shields.**

INTERNATIONAL SCHOOL BUS

1991-88 6 CYL. SERIES 3600/3700/3800 w/DT/DTA466 TURBO DIESEL ENG., w/VARI-RATE SUSPENSION (EXC. MODELS w/ALLISON MTB643 AUTO. TRANS.)

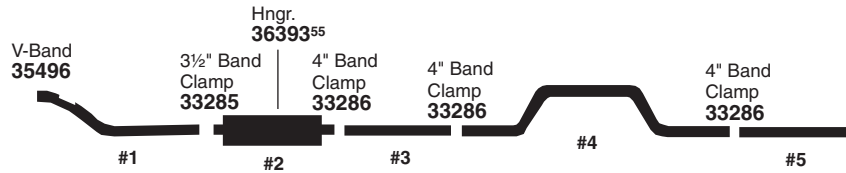

Part Code	#1	#2	#3	#4	#5
W.B.	Front Exhaust Pipe	Muffler	Rear Ext. Pipe	Over Axle Pipe	Tail Pipe
152"	45327	22551	N.A.	46588 (RH Tail Pipe) 46821 (LH Tail Pipe)	49151 ³
170"	45327	22551	N.A.	46588 (RH Tail Pipe) 46821 (LH Tail Pipe)	49151 ³
193" - 276"	45327	22551	49165 ³	46588 (RH Tail Pipe) 46821 (LH Tail Pipe)	49151 ³

1991-88 6 CYL. SERIES 3600/3700/3800 w/DT/DTA466 DIESEL ENG. , w/MOR-RYDE SUSPENSION, LH REAR EXIT TAIL PIPE (EXC. MODELS w/ALLISON MTB643 AUTO. TRANS.)

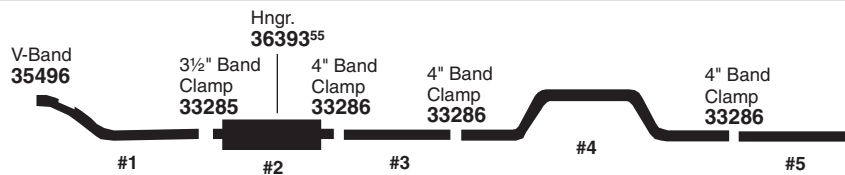

Part Code	#1	#2	#3	#4	#5
W.B.	Front Exhaust Pipe	Muffler	Ext. Pipe	Over Axle Pipe	Tail Pipe
152"	45327	22551	N.A.	46821	49151 ³
170"	45327	22551	N.A.	46821	49151 ³
193" - 276"	45327	22551	49165 ³	46821	49151 ³

1991-88 6 CYL. SERIES 3600/3700/3800 w/DT/DTA466 DIESEL ENG., w/AIR SUSPENSION, (EXC. MODELS w/ALLISON MTB643 TRANSMISSION, BUILT BEFORE 12-10-91), RH EXIT TAIL PIPE

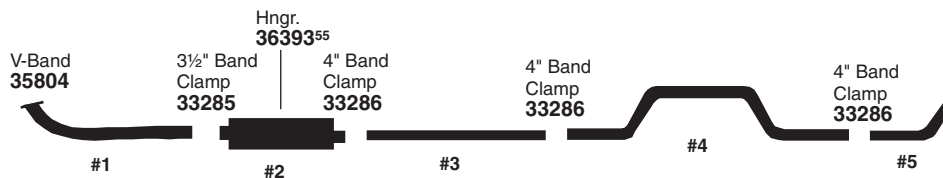

Part Code	#1	#2	#3	#4	#5
W.B.	Front Exhaust Pipe	Muffler	Ext. Pipe	Over Axle Pipe	Tail Pipe
152"	45327	22551	N.A.	47645	49166 ³
170"	45327	22551	N.A.	47645	49166 ³
193" - 276"	45327	22551	49165 ³	47645	49166 ³

N.A. Not available.
³ Cut to required length.
⁵⁵ For accessories, see page 18.

**If welded assembly, replace all required parts.
 WARNING: Reuse or replace O.E. Heat Shields.**

INFORMATION & BUILD TO ORDER
 TOOLS AND ACCESSORIES
 SCHOOL BUS
 MEDIUM DUTY TRUCK GVV 3-6
 HEAVY DUTY TRUCK GVV 7-8
 APPLICATION BY ENGINE
 NOISE AND BACKPRESSURE DATA
 TRACTOR
 MUFFLER SPECS
 O.E. CROSS INDEX

INTERNATIONAL SCHOOL BUS

1991-88 6 CYL. SERIES 3600/3700/3800 w/DT/DTA466 DIESEL ENG. , w/AIR SUSPENSION, LH EXIT TAIL PIPE (EXC. MODELS w/ALLISON MTB643 TRANSMISSION, BUILT BEFORE 12-10-90)

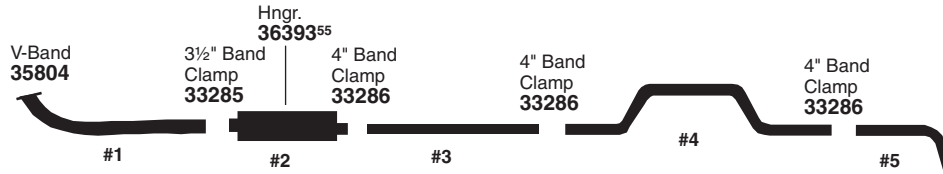

Part Code	#1	#2	#3	#4	#5
W.B.	Front Exhaust Pipe	Muffler	Ext. Pipe	Over Axle Pipe	Tail Pipe
152"	45327	22551	N.A.	47645	49177 ³
170"	45327	22551	N.A.	47645	49177 ³
193" - 276"	45327	22551	49165 ³	47645	49177 ³

1991-88 6 CYL. SERIES 3700/3800 w/DT/DTA466 TURBO DIESEL ENG., w/ALLISON MTB643 AUTO. TRANS., w/AIR SUSPENSION, BEFORE 12-10-90

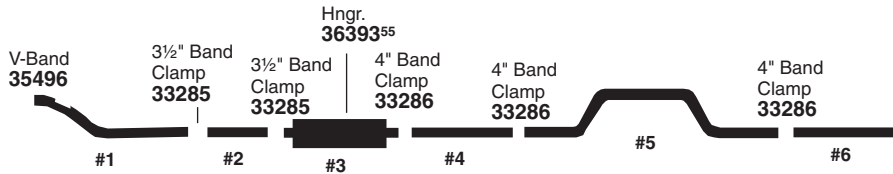

Part Code	#1	#2	#3	#4	#5	#6
W.B.	Front Exhaust Pipe	Front Ext. Pipe	Muffler	Rear Ext. Pipe	Over Axle Pipe	Tail Pipe
152"	N.A.	N.A.	22551	N.A.	47645	49166 (RH Routing) 49177 (LH Routing)
170" - 276"	N.A.	N.A.	22551	49165 ³	47645	49166 (RH Routing) 49177 (LH Routing)

1987-80 6 CYL. SERIES "S" w/DT466 DIESEL ENG., AUTO. TRANS.

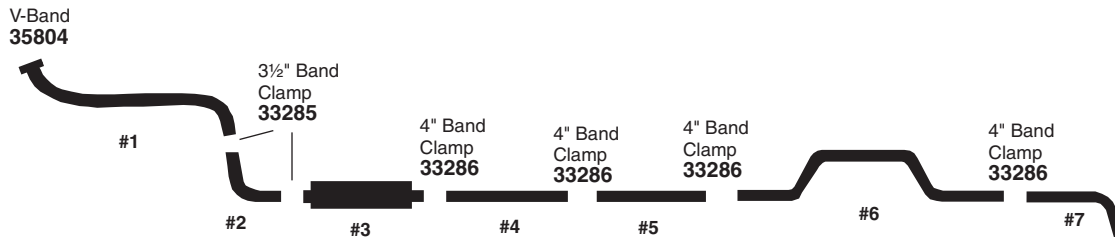

Part Code	#1	#2	#3	#4	#5	#6	#7
W.B.	Front Exhaust Pipe	Exhaust Pipe	Muffler	Ext. Pipe	Ext. Pipe	Over Axle Pipe	Tail Pipe
152" - 276"	N.A.	41366	21832 ⁹	N.A.	49052 ³	46588	49151 ³

N.A. Not available.
3 Cut to required length.

9 Installed reversed.
55 For accessories, see page 18.

**If welded assembly, replace all required parts.
WARNING: Reuse or replace O.E. Heat Shields.**

INTERNATIONAL SCHOOL BUS

1987-80 6 CYL. SERIES "S" w/DT466 DIESEL ENG., MAN. TRANS., LH EXIT

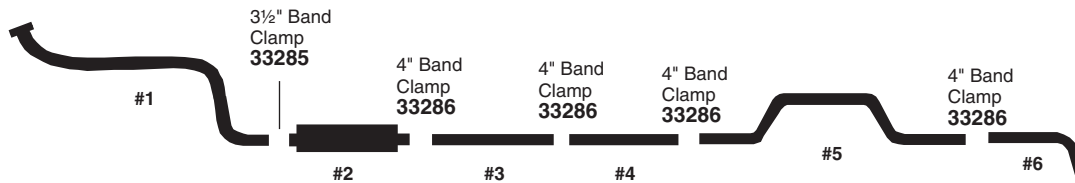

Part Code	#1	#2	#3	#4	#5	#6
W.B.	Front Exhaust Pipe	Muffler	Ext. Pipe	Ext. Pipe	Over Axle Pipe	Tail Pipe
152" - 276"	N.A.	21832 ⁹	N.A.	49052 ³	46588	49151 ³

1987-80 8 CYL. SERIES "S" ALL MODELS w/9.0L DIESEL ENG., LH EXIT TAIL PIPE

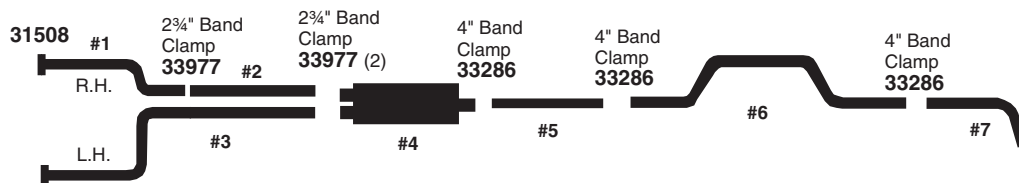

Part Code	#1	#2	#3	#4	#5	#6	#7
W.B.	RH Front Exhaust Pipe	RH Rear Exhaust Pipe	LH Exhaust Pipe	Muffler	Ext. Pipe	Over Axle Pipe	Tail Pipe
152" - 276"	43811	43812	45794	22231	49052 ³	46588	49151 ³

1987-80 8 CYL. SERIES "S" ALL MODELS w/3208 CATERPILLAR DIESEL

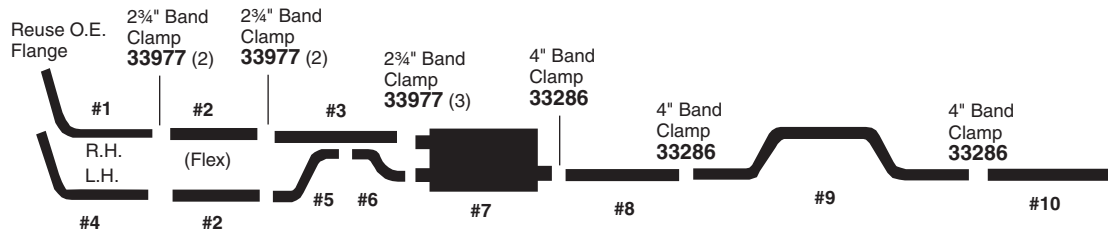

Part Code	#1	#2	#3	#4	#5	#6	#7	#8	#9	#10
W.B.	RH Front Exhaust Pipe	Flex Tubing	RH Rear Ext. Pipe	LH Front Exhaust Pipe	LH Rear Ext. Pipe	LH Rear Ext. Pipe	Muffler	Ext. Pipe	Over Axle Pipe	Tail Pipe
152" - 276"	N.A.	49044 ³ 2 1/2" I.D. ⁵⁶ Flex	N.A.	N.A.	N.A.	N.A.	22231	49052 ³	46588	49151 ³

N.A. Not available.
 3 Cut to required length.
 9 Install reversed.

56 For Flex Tubing options, see page 27.

**If welded assembly, replace all required parts.
 WARNING: Reuse or replace O.E. Heat Shields.**

INFORMATION & BUILD TO ORDER

TOOLS AND ACCESSORIES

SCHOOL BUS

MEDIUM DUTY TRUCK
GVW 3-6

HEAVY DUTY TRUCK
GVW 7-8

APPLICATION BY ENGINE

NOISE AND BACKPRESSURE DATA

TRACTOR

MUFFLER SPECS

O.E. CROSS INDEX

INTERNATIONAL SCHOOL BUS

1987-80 8 CYL. SERIES "S" ALL MODELS w/6.9L DIESEL ENG., DUAL INLET MUFFLER SYSTEM, LH EXIT TAIL PIPE

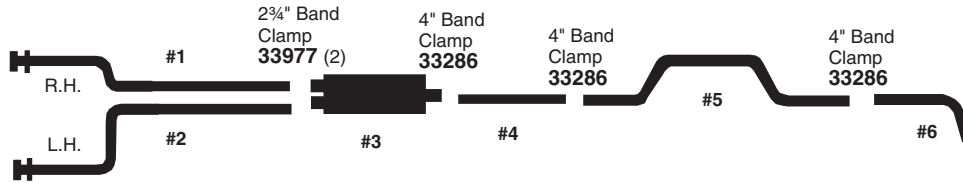

Part Code	#1	#2	#3	#4	#5	#6
W.B.	RH Exhaust Pipe	LH Exhaust Pipe	Muffler	Ext. Pipe	Over Axle Pipe	Tail Pipe
152" - 276"	46670	45946	22231	49052 ³	46588	49151 ³

1986-83 8 CYL. SERIES "S" ALL MODELS w/6.9L DIESEL ENG., w/FLEX TUBING

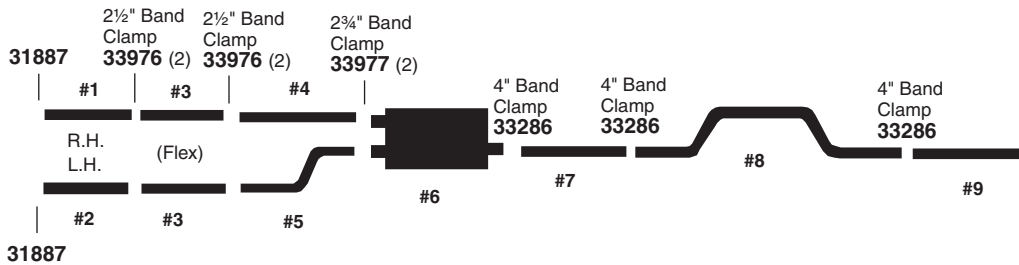

Part Code	#1	#2	#3	#4	#5	#6	#7	#8	#9
W.B.	RH Exhaust Pipe	LH Exhaust Pipe	Front Ext. Pipe	RH Rear Ext. Pipe	LH Rear Ext. Pipe	Muffler	Ext. Pipe	Over Axle Pipe	Tail Pipe
152" - 276"	N.A.‡	N.A.#	N.A.‡#	N.A.‡	N.A.#	22231	49052 ³	46588	49151 ³

1985-80 8 CYL. SERIES "S" ALL MODELS w/392 C.I.D. GAS ENG.

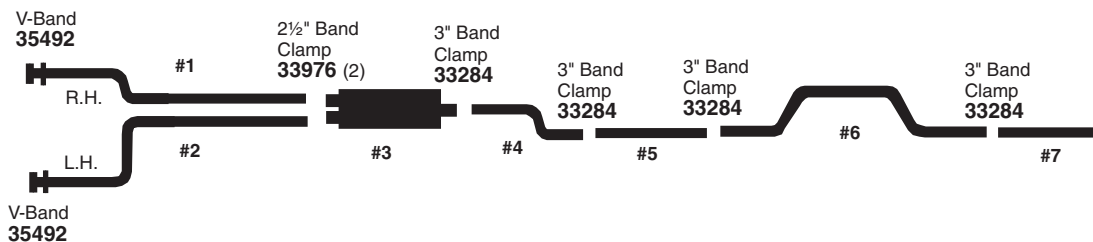

Part Code	#1	#2	#3	#4	#5	#6	#7
W.B.	RH Front Exhaust Pipe	LH Front Exhaust Pipe	Muffler	Ext. Pipe	Ext. Pipe	Over Axle Pipe	Tail Pipe
152" - 276"	45805	46576	22865	48245 ³	49051 ³	46556	N.A.

‡ Use one piece Exhaust Pipe 46670.
Use one piece Exhaust Pipe 45946.

N.A. Not available.
3 Cut to required length.

**If welded assembly, replace all required parts.
WARNING: Reuse or replace O.E. Heat Shields.**

INTERNATIONAL SCHOOL BUS

1985-80 8 CYL. SERIES "S" ALL MODELS w/345 C.I.D. GAS ENG.

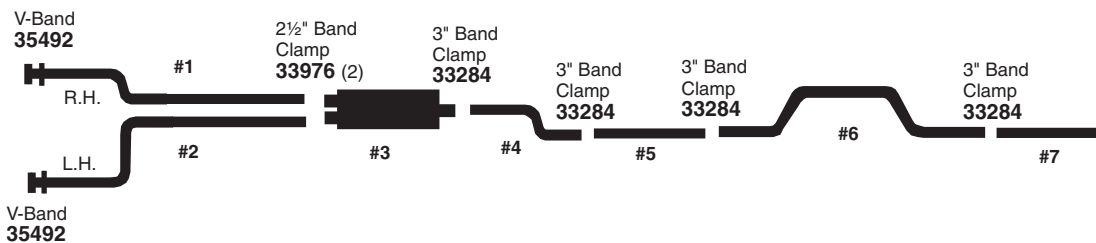

Part Code	#1	#2	#3	#4	#5	#6	#7
W.B.	RH Front Exhaust Pipe	LH Front Exhaust Pipe	Muffler	Ext. Pipe	Ext. Pipe	Over Axle Pipe	Tail Pipe
152" - 276"	45776	46555	22865	48245	49051 ³	46556	N.A.

INFORMATION & BUILD TO ORDER

TOOLS AND ACCESSORIES

SCHOOL BUS

MEDIUM DUTY TRUCK GVV 3-6

HEAVY DUTY TRUCK GVV 7-8

1983-80 8 CYL. SERIES "S" ALL MODELS w/MV404, 446 GAS ENG. (EXC. AUX. SPICER 4 SPEED TRANSMISSION CODE 13552)

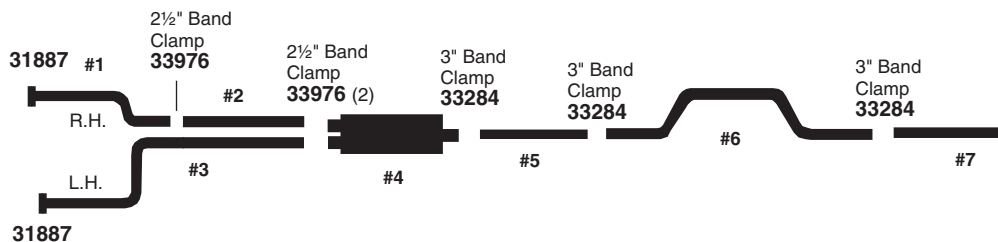

Part Code	#1	#2	#3	#4	#5	#6	#7
W.B.	RH Front Exhaust Pipe	RH Rear Exhaust Pipe	LH Exhaust Pipe	Muffler	Ext. Pipe	Over Axle Pipe	Tail Pipe
152" - 276"	43817	43818	45812	22822	48245 ³	46556	N.A.

APPLICATION BY ENGINE

NOISE AND BACKPRESSURE DATA

TRACTOR

MUFFLER SPECS

O.E. CROSS INDEX

N.A. Not available.
³ Cut to required length.

**If welded assembly, replace all required parts.
 WARNING: Reuse or replace O.E. Heat Shields.**

THOMAS SCHOOL BUS

2001-99 6 CYL. MVP-ER MODEL w/CAT. 3126 TURBO DIESEL, REAR ENGINE, RH BELOW BUMPER EXIT

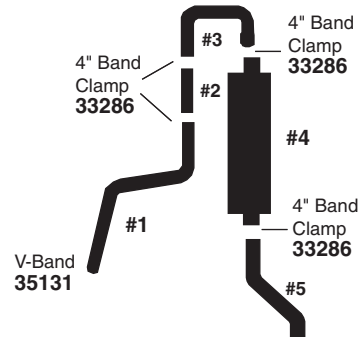

Part Code	#1	#2	#3	#4	#5
W.B.	Front Exhaust Pipe	Flex Tubing	Ext. Pipe	Muffler	Tail Pipe
All	54217	41691 ³	52199	21838	53131

2001-97 6 CYL. MVP E-F MODEL w/CAT. 3126 TURBO DIESEL, PULLER

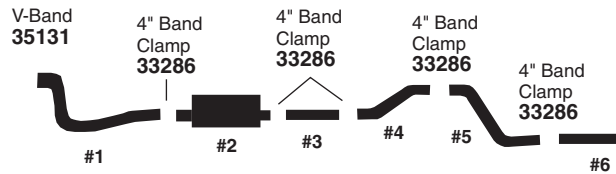

Part Code	#1	#2	#3	#4	#5	#6
W.B.	Front Exhaust Pipe	Muffler	Ext. Pipe	Over Axle Pipe		Tail Pipe
				Front	Rear	
174"	●56168	21838	49161 ³	●54581	●55455	49161 ³

● New number.
³ Cut to required length.

**If welded assembly, replace all required parts.
 WARNING: Reuse or replace O.E. Heat Shields.**

THOMAS SCHOOL BUS

1998-97 6 CYL. MVP-ER MODEL w/5.9L CUMMINS TURBO DIESEL, REAR ENG., RH REAR EXIT TAIL PIPE

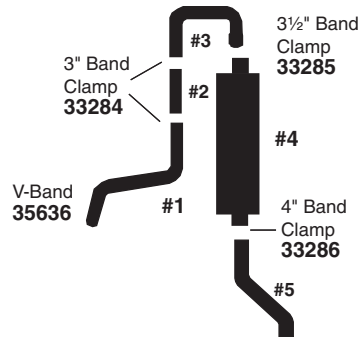

Part Code	#1	#2	#3	#4	#5
W.B.	Front Exhaust Pipe	Flex Tubing	Ext. Pipe	Converter/Muffler	Tail Pipe
All	53161	42492	52163	N.A.	53160 (Thru Bumper) 53131 (Under Bumper)

1998-96 6 CYL. MVP-ER MODEL w/CAT. 3116 TURBO DIESEL, REAR ENG., RH BELOW BUMPER EXIT

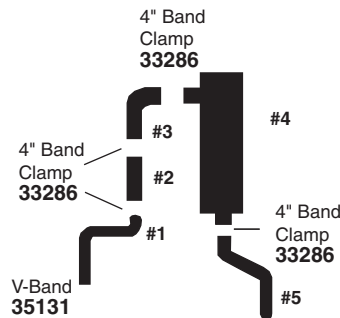

Part Code	#1	#2	#3	#4	#5
W.B.	Front Exhaust Pipe	Flex Tubing	Ext. Pipe	Converter/Muffler	Tail Pipe
All	53130	41691	41778	N.A.	53131

N.A. Not available.

**If welded assembly, replace all required parts.
WARNING: Reuse or replace O.E. Heat Shields.**

INFORMATION
& BUILD TO
ORDER

TOOLS AND
ACCESSORIES

SCHOOL BUS

MEDIUM
DUTY TRUCK
GVW 3-6

HEAVY DUTY
TRUCK
GVW 7-8

APPLICATION
BY ENGINE

NOISE AND
BACKPRESSURE
DATA

TRACTOR

MUFFLER
SPECS

O.E. CROSS
INDEX

THOMAS SCHOOL BUS

1996-95 6 CYL. MVP-ER MODEL w/CUMMINS 5.9L TURBO DIESEL, LH REAR EXIT TAIL PIPE

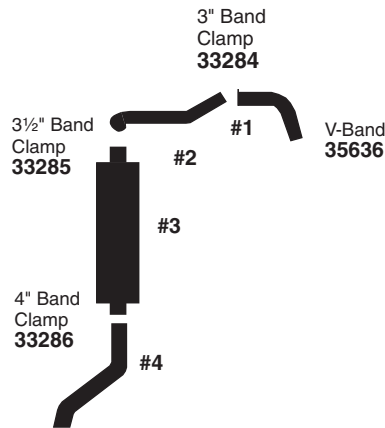

Part Code	#1	#2	#3	#4
W.B.	Exhaust Pipe	Rear Ext. Pipe	Converter/Muffler	Tail Pipe
All	52160	52161	N.A.	52162

1995-92 6 CYL. MVP MODEL w/CAT. 3116 TURBO DIESEL, REAR ENG.

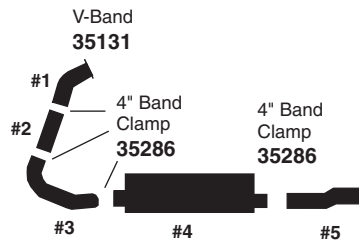

Part Code	#1	#2	#3	#4	#5
W.B.	Front Exhaust Pipe	Flex Tubing	Ext. Pipe	Muffler	Tail Pipe
All	41754	42423 ^{3,56}	52034	21174	41097

N.A. Not available.
 3 Cut to required length.
 56 For Flex Tubing options, see page 27.

**If welded assembly, replace all required parts.
 WARNING: Reuse or replace O.E. Heat Shields.**

THOMAS SCHOOL BUS

1993-90 V6 CYL. SAF-T-LINER w/6V92 REAR ENGINE MODEL, REAR EXIT TAIL PIPE

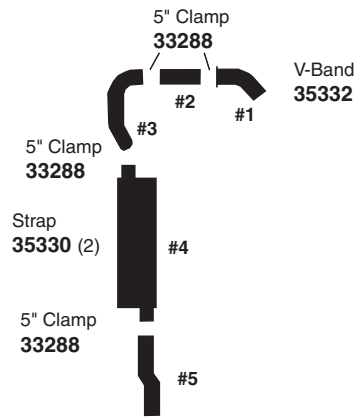

Part Code	#1	#2	#3	#4	#5
W.B.	Exhaust Pipe	Flex Tubing	Ext. Pipe	Muffler	Tail Pipe
All	N.A.	42424 ^{3,56}	N.A.	22552	N.A.

1993-89 6 CYL. ALL MODELS w/CUMMINS 6BTA, 6CTA, REAR ENG., REAR EXIT TAIL PIPE

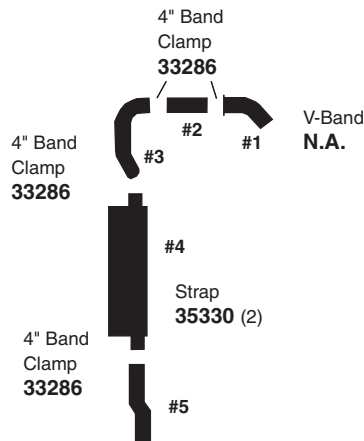

Part Code	#1	#2	#3	#4	#5
W.B.	Exhaust Pipe	Flex Tubing	Rear Ext. Pipe	Muffler	Tail Pipe
All	N.A.	42423 ^{3,56}	43249 (6BTA) 43229 (6CTA)	21174	41097 (Rear Exit) N.A. (Thru Bumper)

N.A. Not available.
 3 Cut to required length.
 56 For Flex Tubing options, see page 27.

**If welded assembly, replace all required parts.
 WARNING: Reuse or replace O.E. Heat Shields.**

INFORMATION & BUILD TO ORDER

TOOLS AND ACCESSORIES

SCHOOL BUS

MEDIUM DUTY TRUCK GVV 3-6

HEAVY DUTY TRUCK GVV 7-8

APPLICATION BY ENGINE

NOISE AND BACKPRESSURE DATA

TRACTOR

MUFFLER SPECS

O.E. CROSS INDEX

THOMAS SCHOOL BUS

1993-89 8 CYL. SAF-T-LINER w/8.2L TURBO DIESEL, REAR ENG. MODEL,
REAR EXIT TAIL PIPE

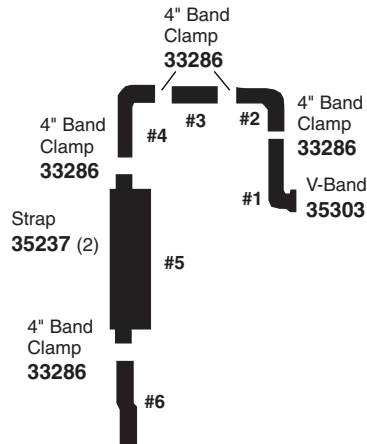

Part Code	#1	#2	#3	#4	#5	#6
W.B.	Exhaust Pipe	Front Ext. Pipe	Flex Tubing	Rear Ext. Pipe	Muffler	Tail Pipe
All	42446 (w/pyrometer) N.A. (w/o pyrometer)	42085	41545	42099	22004	41544

1993-89 8 CYL. SAF-T-LINER w/8.2L TURBO DIESEL, REAR ENGINE MODEL,
STREET SIDE EXIT

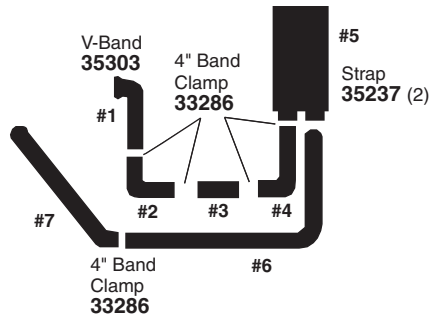

Part Code	#1	#2	#3	#4	#5	#6	#7
W.B.	Exhaust Pipe	Front Ext. Pipe	Flex Tubing	Rear Ext. Pipe	Muffler	Ext. Pipe	Tail Pipe
All	42446 (w/pyrometer) N.A. (w/o pyrometer)	42085	41545	42099	21923	46780	N.A.

N.A. Not available.

**If welded assembly, replace all required parts.
WARNING: Reuse or replace O.E. Heat Shields.**

THOMAS SCHOOL BUS

1991-84 8 CYL. SAF-T-LINER MODELS (REAR ENGINE) w/CATERPILLAR 3208 NATURALLY ASPIRATED DIESEL ENG.

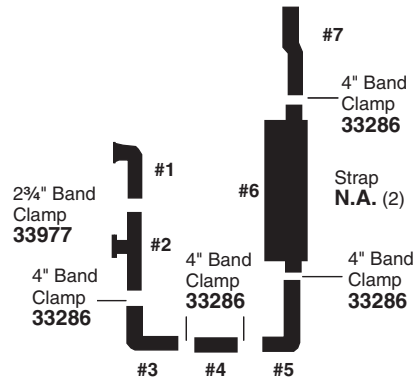

Part Code	#1	#2	#3	#4	#5	#6	#7
W.B.	LH Manifold Pipe	RH Manifold Pipe	Front Exhaust Pipe	Flex Tubing	Rear Exhaust Pipe	Muffler	Tail Pipe
All	N.A.	N.A.	42085	41545	42099	22004	41544

1991-84 8 CYL. SAF-T-LINER MODELS (REAR ENG.) w/CATERPILLAR 3208 TURBO DIESEL ENG.

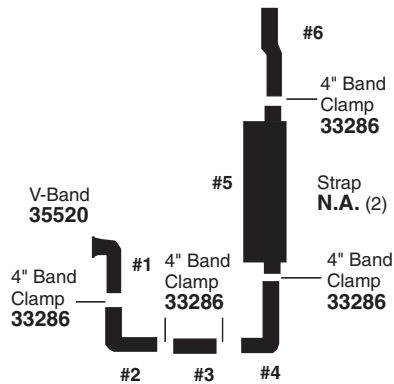

Part Code	#1	#2	#3	#4	#5	#6
W.B.	Manifold Pipe	Front Exhaust Pipe	Flex Tubing	Rear Exhaust Pipe	Muffler	Tail Pipe
All	N.A.	42085	41545	42099	22004	41544

N.A. Not available.

**If welded assembly, replace all required parts.
WARNING: Reuse or replace O.E. Heat Shields.**

INFORMATION & BUILD TO ORDER

TOOLS AND ACCESSORIES

SCHOOL BUS

MEDIUM DUTY TRUCK GVV 3-6

HEAVY DUTY TRUCK GVV 7-8

APPLICATION BY ENGINE

NOISE AND BACKPRESSURE DATA

TRACTOR

MUFFLER SPECS

O.E. CROSS INDEX

THOMAS SCHOOL BUS

1991-84 8 CYL. REAR ENGINE MODELS w/CATERPILLAR 3208 NATURALLY ASPIRATED DIESEL ENG., STREET SIDE EXIT

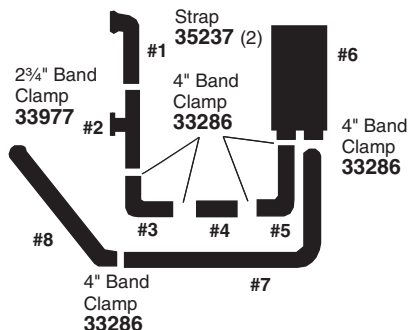

Part Code	#1	#2	#3	#4	#5	#6	#7	#8
W.B.	LH Manifold Pipe	RH Manifold Pipe	Front Exhaust Pipe	Flex Tubing	Rear Exhaust Pipe	Muffler	Ext. Pipe	Tail Pipe
All	N.A.	N.A.	42085	41545	42099	21923	46780	N.A.

1991-84 8 CYL. REAR ENGINE MODELS w/CATERPILLAR 3208 TURBO DIESEL ENG., STREET SIDE EXIT

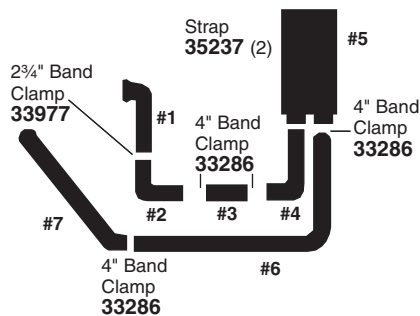

Part Code	#1	#2	#3	#4	#5	#6	#7
W.B.	Manifold Pipe	Front Exhaust Pipe	Flex Tubing	Rear Exhaust Pipe	Muffler	Ext. Pipe	Tail Pipe
All	N.A.	42085	41545	42099	21923	46780	N.A.

N.A. Not available.

**If welded assembly, replace all required parts.
WARNING: Reuse or replace O.E. Heat Shields.**

school bus exhaust systems

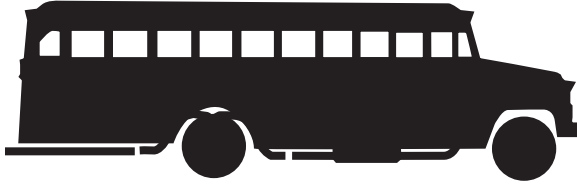

universal over-axle pipes

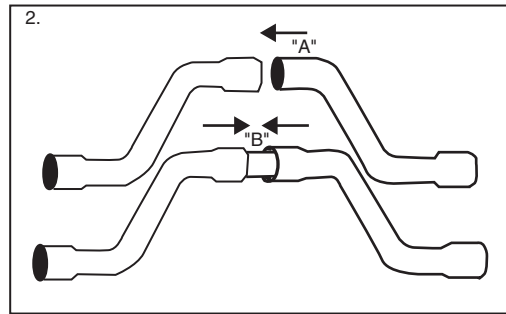
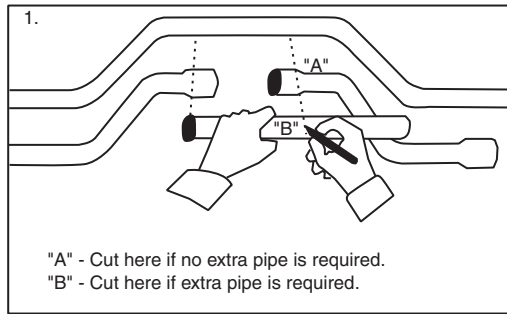
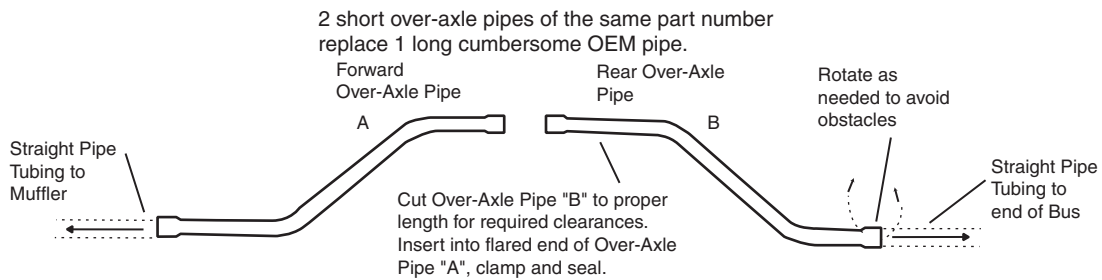

ALUMINIZED UNIVERSAL OVER-AXLE PIPE

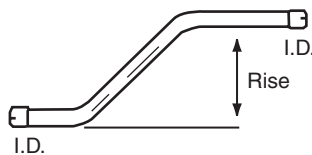

Part No.	I.D.	Lgth.	Rise
44262	3	40	15
44055	4	40	15

"ONE-PIECE" UNIVERSAL OVER-AXLE PIPE

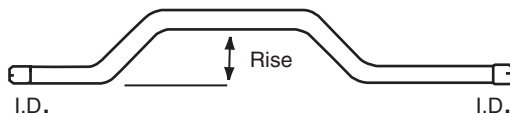

Part No.	I.D.	Lgth.	Rise
48225	3	84%	15

INFORMATION
& BUILD TO
ORDER

TOOLS AND
ACCESSORIES

SCHOOL BUS

MEDIUM
DUTY TRUCK
GVW 3-6

HEAVY DUTY
TRUCK
GVW 7-8

APPLICATION
BY ENGINE

NOISE AND
BACKPRESSURE
DATA

TRACTOR

MUFFLER
SPECS

O.E. CROSS
INDEX

SCHOOL BUS

“Y” ADAPTER (w/Gussets)

Y Adapter to convert IHC/Navistar, Ford 2½" dual inlet muffler applications to a single 3" inlet muffler. Use with muffler 22389.

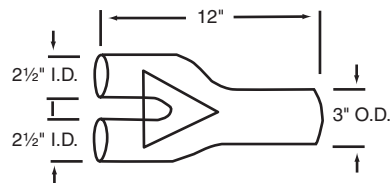

40255
(Aluminized)

LEFT SIDE EXIT APPLICATIONS

O.E./Make Engine Description	Outlet Type	Pipe O.D. 4"	Style
90° Left Side Exit Application			
3700 & 3800 Series S	w/o Turndown	44449	A
45° Left Side Exit Application			
International	w/o Turndown	48277	B¹
	w/Turndown	48296³	C¹
65° Left Side Exit Application			
Bluebird TC-2000, Cummins 5.9	w/o Turndown	47643	B¹

¹ Installs over the drive train.

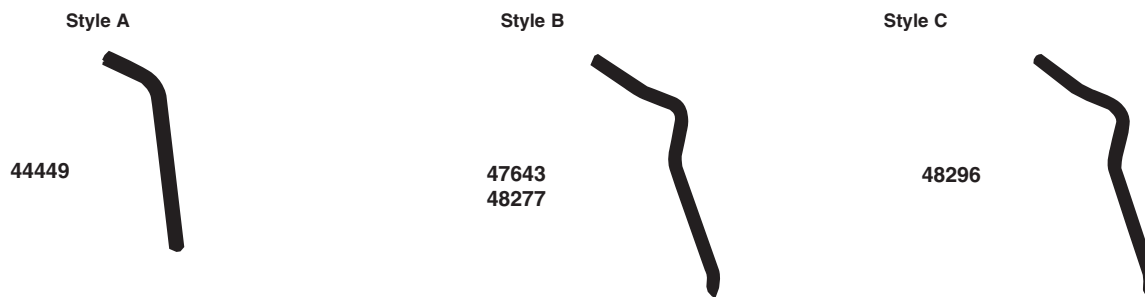

UNIVERSAL SIDE EXIT TAIL PIPE

Right Hand Muffler with 4" I.D. Outlet -Over Drive Shaft - Exit on Left Hand Side of Bus in Front of Rear Wheels

#1	#2	#3	#4	#5	#6
Connector Pipe	4" Band Clamp	Tail Pipe	Tail Pipe Hanger	Tail Pipe Bracket	Tail Pipe Clamp
●53605 ³	●33286	●55466	●36449	●36452	●36451

³ Cut to required length.

